

Russound®

CAV6.6

**Six-Zone, Six-Source
Audio-Video Controller Amplifier**

INSTRUCTION MANUAL



IMPORTANT SAFEGUARDS



WARNING: TO REDUCE THE RISK OF FIRE OR ELECTRIC SHOCK, DO NOT EXPOSE THIS APPLIANCE TO RAIN OR MOISTURE.



CAUTION: TO REDUCE THE RISK OF ELECTRIC SHOCK, DO NOT REMOVE COVER. NO USER - SERVICEABLE PARTS INSIDE. REFER SERVICING TO QUALIFIED SERVICE PERSONNEL.

The lightning flash with arrowhead symbol, within an equilateral triangle, is intended to alert the user to the presence of uninsulated "dangerous voltage" within the product's enclosure that may be of sufficient magnitude to constitute a risk of electric shock to persons.

The exclamation point within an equilateral triangle is intended to alert the user to the presence of important operating and maintenance (servicing) instructions in the literature accompanying the appliance.

POWER CORD NOTICE FOR INTERNATIONAL OPERATION

For 230V, 50Hz operation please select the power cord for your area. Select the plug for your area at one end and a IEC320 connector at the other. It is not necessary to make any other changes. If you have any questions please call Russound Inc. at 1-800-638-8055 or 603-659-5170

Safety Instructions:

1. Read Instructions - All the safety and operating instructions should be read before the appliance is operated.
2. Retain Instructions - The safety and operating instructions should be retained for future reference.
3. Heed Warnings - All warnings on the appliance in the operating instructions should be adhered to.
4. Follow Instructions - All operating and user instructions should be followed.
5. Water and Moisture - The appliance should not be used near water; for example, near a bathtub, wash-bowl, kitchen sink, laundry tub, in a wet basement, or near a swimming pool.
6. Carts and Stands - The appliance should be used only with a cart or stand that is recommended by the manufacturer. An appliance and cart combination should be moved with care. Quick stops, excessive force and uneven surfaces may cause the appliance and cart combination to overturn.
7. Wall or ceiling Mounting - The appliance should be mounted to a wall or ceiling only as recommended by the manufacturer.
8. Ventilation - The appliance should be situated so that its location or position does not interfere with its proper ventilation. For example, the appliance should not be situated on a bed, sofa, rug, or similar surface that may block the ventilation openings, or placed in a built-in installation, such as a bookcase or cabinet that may impede the flow of air through the ventilation openings.



9. Heat - The appliance should be situated away from heat sources such as radiators, heat registers, stoves, or other appliances (including amplifiers) that produce heat.
10. Power Sources - The appliance should be connected to a power supply only of the type described in the operating instructions or as marked on the appliance.
11. Grounding or Polarization - Precaution should be taken so that the grounding or polarization means of an appliance is not defeated.
12. Power Cord Protection - Power supply cords should be routed so that they are not likely to be walked on or pinched by items placed upon or against them, paying particular attention to cords at plugs, receptacles, and the point where they exit from the appliance.
13. Cleaning - The appliance should be cleaned only as recommended by the manufacturer.
14. Non-use Periods - The power cord of the appliance should be unplugged from the outlet when left unused for a long period of time.
15. Object and Liquid Entry - Care should be taken so that objects do not fall and liquids are not spilled into the enclosure through the openings.
16. Damage Requiring Service - The appliance should be serviced by qualified service personnel when:

A. The power supply cord or the plug has been damaged; or

B. Objects have fallen, liquid has been spilled into the appliance; or
C. The appliance has been exposed to rain; or

D. The appliance does not appear to operate normally; or

E. The appliance has been dropped or the enclosure is damaged.

17. Servicing - The user should not attempt to service the appliance beyond that described in the operating instructions. All other servicing should be referred to qualified service personnel.

Precautions:

1. Power – WARNING: BEFORE TURNING ON THE POWER FOR THE FIRST TIME, READ THE FOLLOWING SECTION CAREFULLY. All models are designed for use with either AC120V, 60Hz or AC240, 50Hz voltages. The unit will autoswitch to either of these voltages
2. Do Not Touch The CAV6.6 With Wet Hands – Do not handle the CAV6.6 or power cord when your hands are wet or damp. If water or any other liquid enters the CAV6.6 cabinet, take the CAV6.6 to a qualified service person for inspection.
3. Location of CAV6.6 – Place the CAV6.6 in a well - ventilated location. Take special care to provide plenty of ventilation on all sides of the CAV6.6 especially when it is placed in an audio rack. If ventilation is blocked, the CAV6.6 may overheat and malfunction. Do not expose the CAV6.6 to direct sun light or heating units as the CAV6.6 internal components temperature may rise and shorten the life of the components. Avoid damp and dusty places.
4. Care – From time to time you should wipe off the front and side panels of the cabinet with a soft cloth. Do not use rough material, thinners, alcohol or other chemical solvents or cloths since this may damage the finish or remove the panel lettering.



TABLE OF CONTENTS



USER SECTION

Product Introduction	5
Component Guide	
CAV6.6 Controller (Front panel operation)	6-7
UNO-S2 Keypad	8
UNO-TS2 Touchscreen	9
UNO-S1 Keypad	10
SRC2 Remote Control	11
Operation	
UNO-S2 Keypad Button Functions	12
UNO-S2 User Menu - Setting Preferences	13
UNO-S1 Keypad Button Functions	14
UNO-S1 User Menu - Setting Preferences	15
UNO-TS2 Touchscreen Button Functions	16
UNO-TS2 - Setting Preferences	17

INSTALLER SECTION

Getting Started	
Unpacking	18
System Components	18
Tools Needed	18
System Installation Considerations	18
Connection Tips	18
Component Guide	
CAV6.6 Controller Front Panel	19
CAV6.6 Controller Rear Panel	20-21
UNO Keypad OS Update Port	22
UNO Keypad Rear Panel	23
Wiring Instructions	
Keypad Wiring	24
Speaker Wiring	24
UNO-S2 Keypad Installation	
Keypad Connections	25
IR Receiver Connection	26
Keypad Location	27
Keypad Installation	27
Making Connections	
UNO Keypad Port Connection	28
Source Audio/Video Input Connections	29
Source Audio/Video Loop Output Connection	30
Speaker Connections	31
Accessory IR Connection	32
Zone Audio/Video Outputs	33
A-BUS Ready Sub-zone Connection	34
12VDC Trigger In/Out	
Home Theater Trigger In	35
50mA Trigger Out	35
Page Trigger In/Out	36-37
Page Audio/Video In	36-37
Zone Trigger Out	38



TABLE OF CONTENTS

RNET Link In/Out - Multiple Controllers.....	39
RNET Link In/Out - RNET-enabled Components	40
RS-232 Interface	41
Programming Center Keypad Port Connection.....	42
Initial Install Test	43
Programming	
System Programming Overview	44-45
Source Information Form	46
Zone Information Form	47
Macro Editor Form	48
Installation Menu.....	49-61
Installation Menu Overview	49
Source Setup	50-56
Basic Setup	50-51
Zone Setup	56-57
Controller Setup	57
Power Management	57-59
Learn IR	59-60
Macro Editor	60-61
System Info.....	61
Setup Menu Flow Charts.....	62-72
Basic Setup	62
Key Configuration	63
Source Names/Volume Trim.....	64
Numeric IR.....	65
Source Select/Number of Sources	66
Zone Setup	67
Controller Setup	68
Power Management.....	69
Learn IR.....	70
Macro Editor	71
System Info.....	72
REFERENCE SECTION	
Keypad Diagnostic Menu	73
IR Device Code List	74-77
Source Names List.....	78-79
Sample System Configurations	
1 -Six Zones and Six Sources	80-81
2 - Integrate Multiple CAV6.6's	82-83
3 - Zone Keypad Expansion	84-85
4 - A-BUS Ready Sub-zone Addition	86-87
5 - Additional Amplification	88-89
6 - Home Theater	90-91
IR Key Code List	92-113
Technical Specifications.....	114
Warranty	115

PRODUCT INTRODUCTION



Thank you for choosing the Russound® CAV6.6 controller amplifier to enhance your home with distributed audio and video. This controller's state-of-the-art features and components blend seamlessly with your unique lifestyle and preferences.

Besides distributing and controlling six A-V sources to six rooms (zones), your CAV6.6 offers many features that increase your enjoyment of living. Here are several features that you may find particularly beneficial.

Favorites

The F1 and F2 buttons on the UNO-S2 keypad, UNO-TS2 touchscreen and SRC2 remote control are preset favorites. These easy-to-set buttons make it possible to hear your favorite radio station or watch your favorite satellite channel at just the right volume in your room with just a button push. Want something new? Just re-save the Favorite with a new choice.

Do Not Disturb

The Do Not Disturb mode prevents unwanted interruptions in your room and stops changes to your selected A/V source. You may have a nursery or study that you want to keep quiet, or maybe you are watching a DVD and don't want it interrupted. Simply set the Do Not Disturb mode to "on" using the User Menu, and be free from paging, Party Mode interaction and system-wide functions like "All On" or "All Off."

Party Mode

Ready to set the mood? In Party Mode, you just pick the source and the sound settings and hear the music throughout all the rooms. The Master keypad simultaneously controls all the keypads in all the rooms to effortlessly select or control the components. A great benefit of the Party Mode feature is the ability to transfer the Master keypad mode to any keypad in the system. If the living room is the center of the party, use that room's keypad as Master. If the party moves to the sunroom and porch, that room's keypad can be set to Master instead.

Front (Aux) A/V In

This handy feature lets you easily hook up an additional temporary audio-video source through the front of the controller. This way, your teenager can set up a game console when his friends come over, and easily take it down without having to leave the games set up in the living room. Or your family can watch the video camera playback of the holiday gathering while everyone is still there.

Here at Russound we are proud to continue providing innovative and intuitive A/V product solutions to the world. When you link the industry-leading CAV6.6 controller with Russound's commitment to its products and customers, you have truly made – "the right connection."

USER COMPONENT GUIDE

CAV6.6 Controller-Front Panel

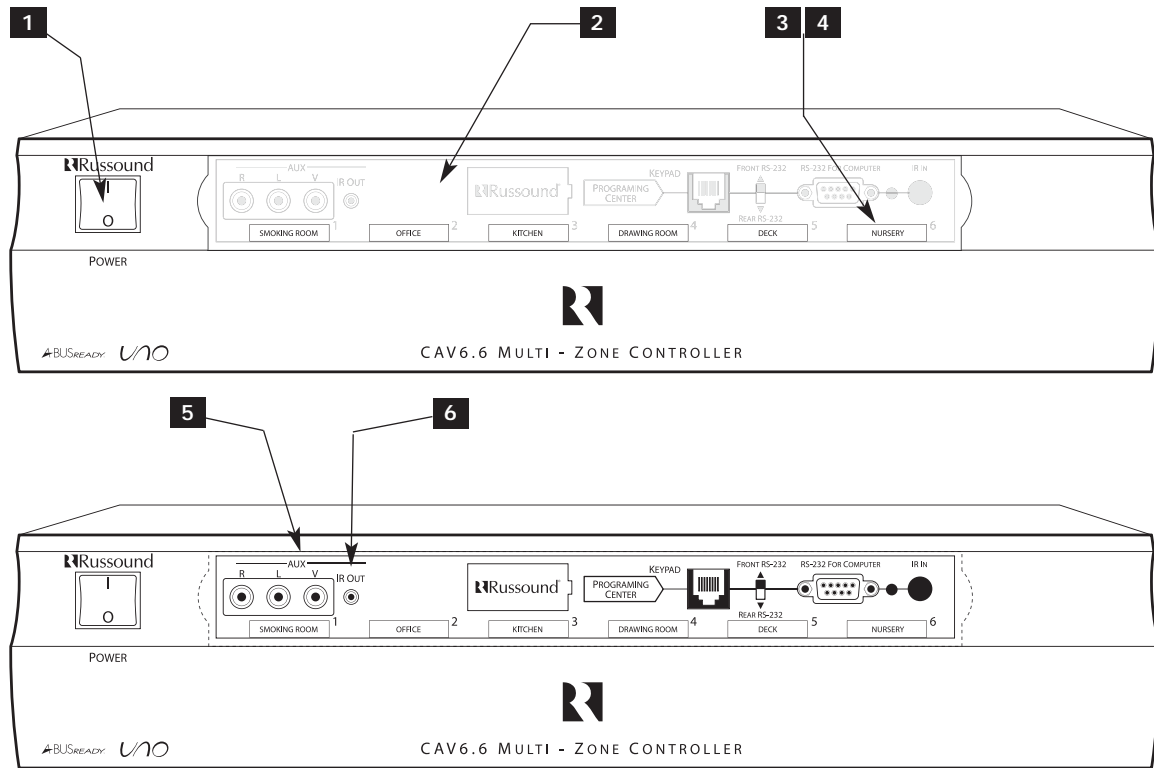

- 1** MAIN POWER SWITCH - Supplies power to the CAV6.6. The power switch for the CAV6.6 controller is "on" in the up position.
- 2** REMOVABLE COVER LENS - Covers the connections on the front of the CAV6.6
- 3** ROOM LED ON/OFF INDICATORS - Indicates when a room is on (green) or off (red)
- 4** ROOM LABEL WINDOW - Holds the selected room Label (included)
- 5** AUX A/V LINE INPUTS - Supports connection of a seventh A/V source to the CAV6.6
- 6** AUX IR OUT PORT - Connects IR emitter for IR control of the Aux A/V source component

CAV6.6 Controller-Front Panel

Front A/V AUX Connections

The AUX Input is located to the right of the power switch on the front panel. Connect the Left, Right, and Video Input Connectors to the source component using quality RCA signal cables.

The AUX IR jack adjacent to the line input accepts an IR Emitter with a 1/8" plug (e.g., Russound 845.1 IR emitter). The emitter's other end attaches to the IR window of the component to control the auxiliary source.

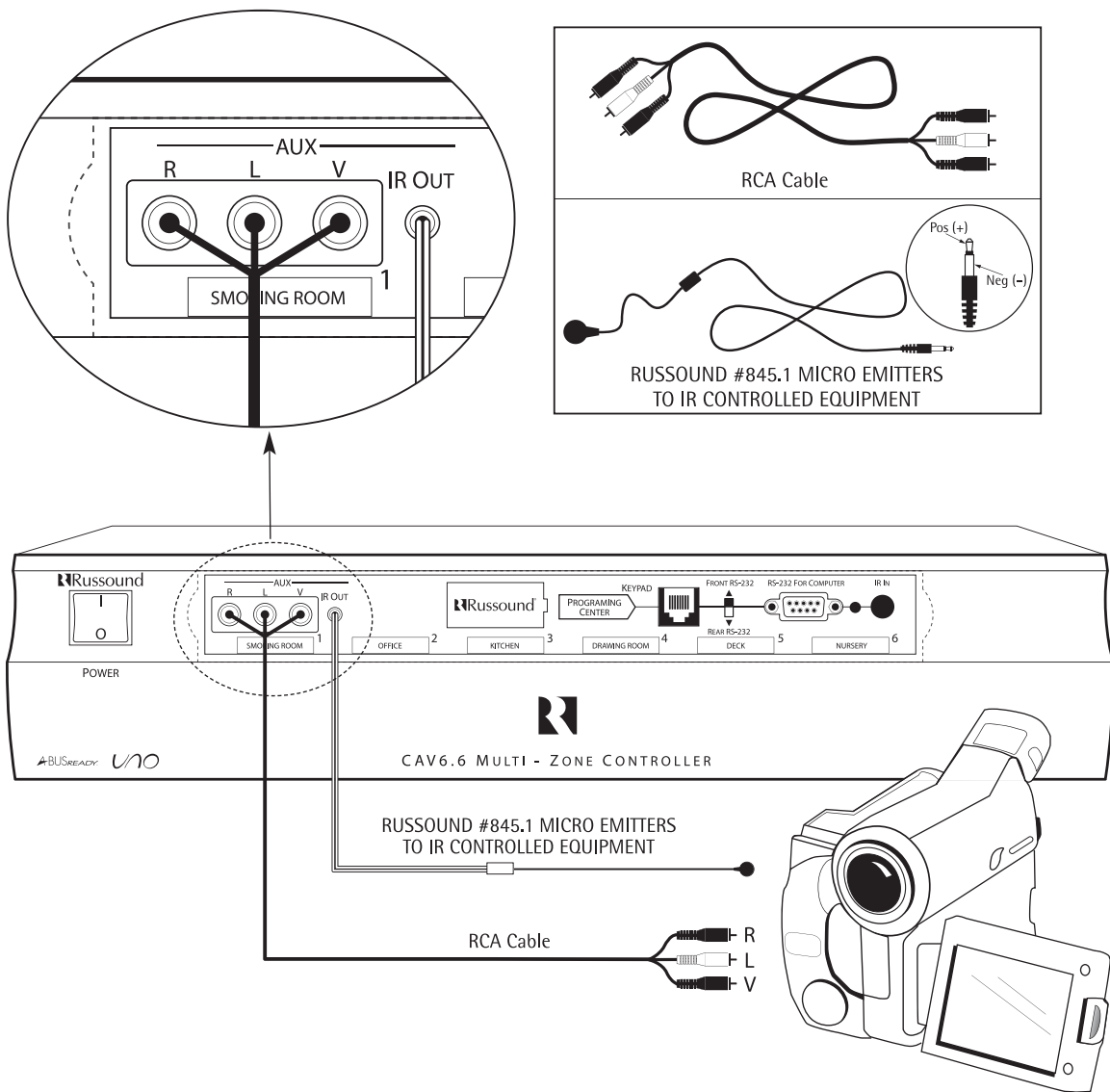

USER COMPONENT GUIDE

UNO-S2 Keypad

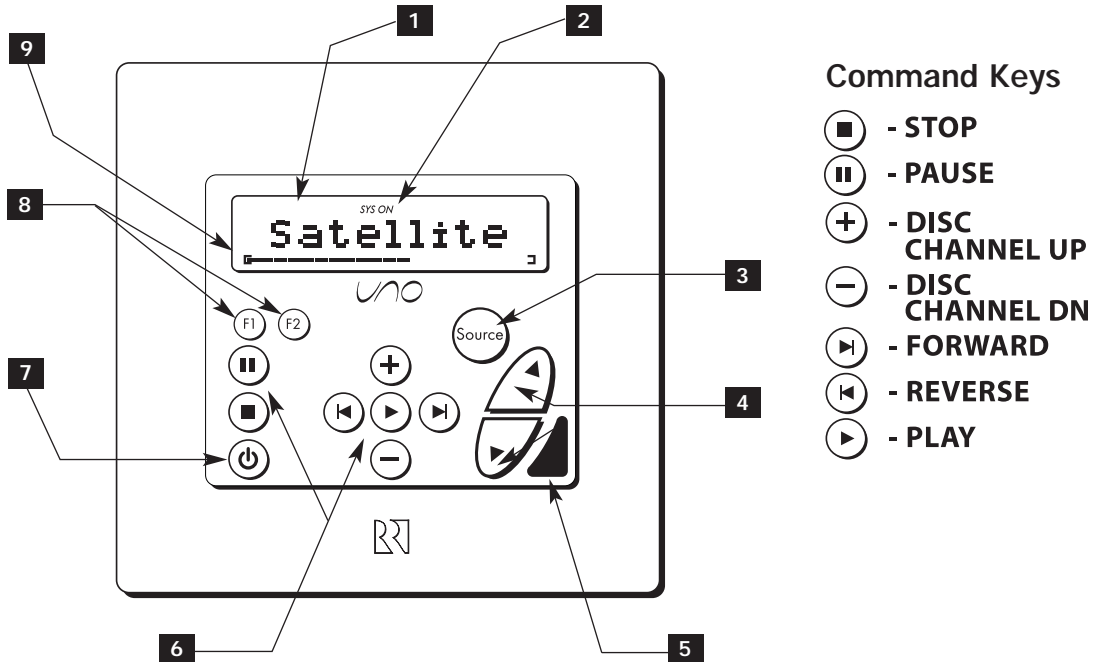

- 1** LCD PANEL - 12-character backlit display shows status of the room, source, volume, and more
- 2** MODE - "SYS-ON" indicates system on, "DND" shows when Do Not Disturb is active, "SHARED" indicates same source selected in multiple rooms, "PARTY" shows when Party Mode is enabled, and "MASTER" indicates the Master Keypad in Party Mode
- 3** SOURCE SELECT BUTTON - Scrolls through the sources directly connected to the CAV6.6. Press and hold brings up the USER MENU for loudness, bass, treble, etc.
- 4** VOLUME UP/DOWN BUTTONS - Raises and lowers the volume for the room
- 5** IR RECEIVER - Receives IR signals and passes them to the controller and source equipment. Also used when operating the UNO Keypad by using the SRC2 remote
- 6** COMMAND KEYS - Pressing the command keys controls the source equipment
- 7** POWER BUTTON - Turns room ON or OFF when pressed once, press and hold a second time will turn on or off all CAV6.6 rooms
- 8** F1 AND F2 BUTTONS - Selects Favorite 1 or Favorite 2 - preset user-selected favorite settings per room
- 9** VOLUME INDICATOR - Line extends to indicate volume level of the room

UNO-TS2 Touchscreen

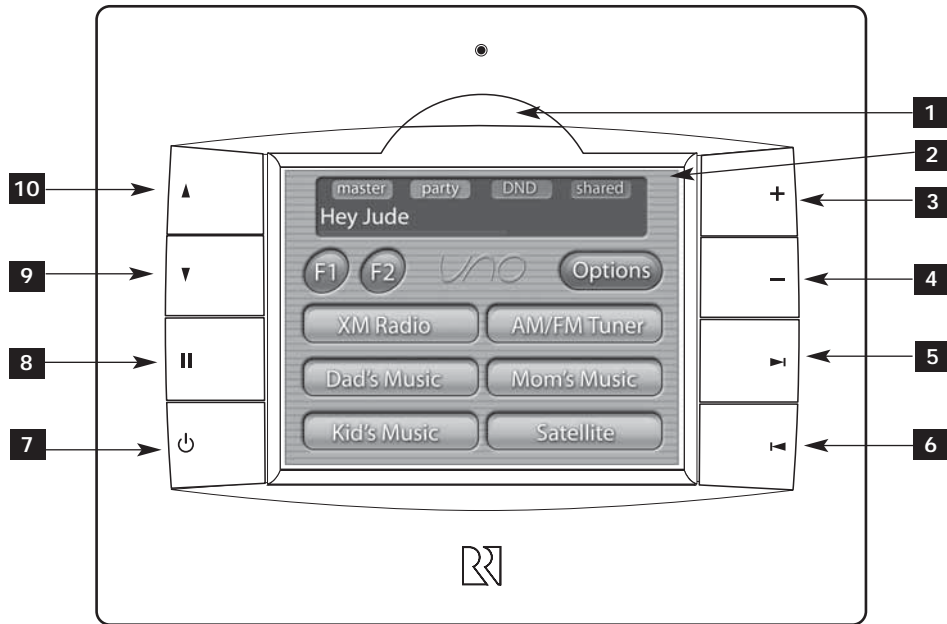



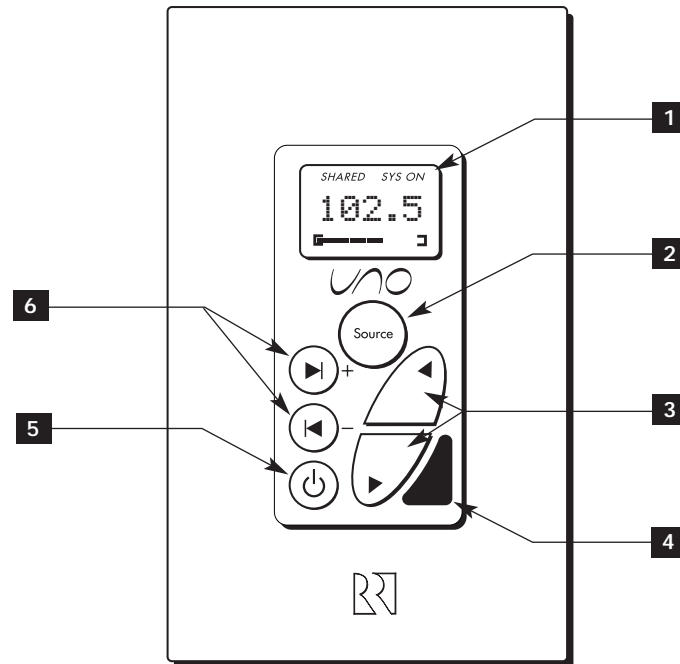

- 1** IR RECEIVER - Receives IR signals and passes them to the controller and source equipment. Also used when operating the touchscreen by using the SRC2 remote
- 2** TOUCHSCREEN - Full color resistive touchscreen with multi-sound feedback. Screen can be programmed to go blank after a period of inactivity. Touching the screen anywhere reactivates it.
- 3** PLUS - Adjust setting for selected source
- 4** MINUS - Adjust setting for selected source
- 5** NEXT - Go to next selection for selected source
- 6** PREVIOUS - Go to previous selection for selected source
- 7** POWER - Turn room power on/off. Press and hold for system all on/all off
- 8** PAUSE - Pause/mute for selected source
- 9** VOLUME DOWN - Adjust volume down for room controlled by touchscreen
- 10** VOLUME UP - Adjust volume up for room controlled by touchscreen

USER COMPONENT GUIDE

UNO-S1 Keypad



- 1** LCD PANEL - 5-character backlit display shows source, volume and room status (messages scroll, then display first 5 characters of message)
- 2** SOURCE SELECT - Scrolls through the available sources. Press and hold brings up the USER MENU for loudness, bass, treble, etc.
- 3** VOLUME UP/DOWN BUTTONS - Raises and lowers the volume for the room
- 4** IR RECEIVER - Receives IR signals and passes them to the controller and source equipment. Also used when operating the UNO Keypad by using the SRC2 remote
- 5** POWER BUTTON - Turns room ON or OFF when pressed once, press and hold a second time will turn on or off all rooms
- 6** COMMAND KEYS - Pressing the command keys controls the source equipment
 -  - **FORWARD** (press)
 -  - **DISC, CHANNEL UP** (press and hold)
 -  - **REVERSE** (press)
 -  - **DISC, CHANNEL DOWN** (press and hold)

USER COMPONENT GUIDE

SRC2 Remote Control

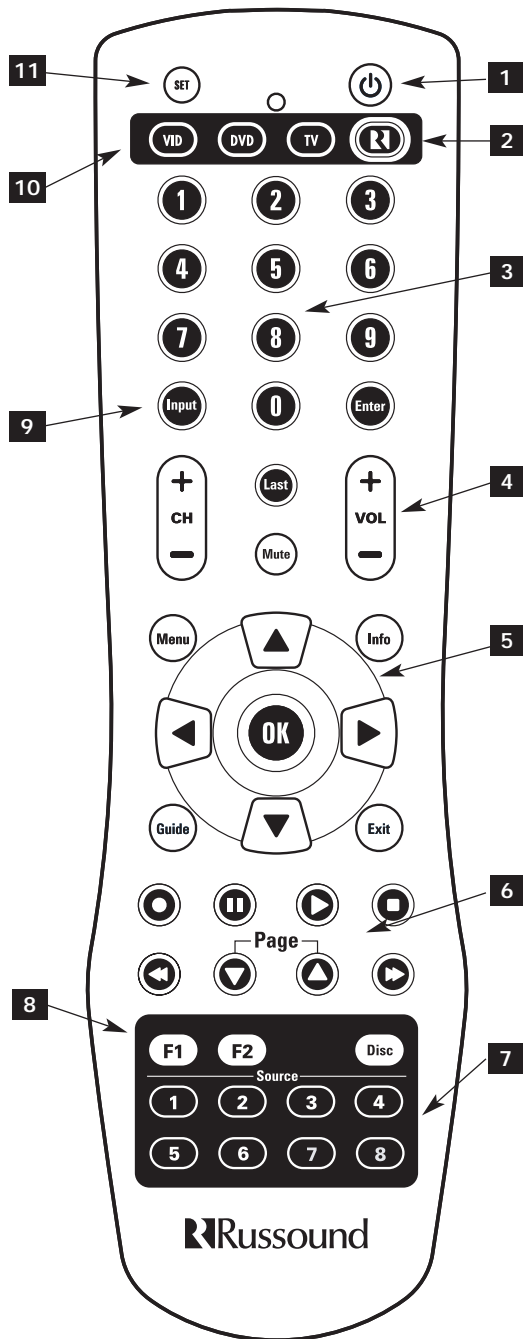



- 1** POWER - Turns room or Local Source on and off.
- 2** RUSSOUND DEVICE BUTTON - Used for SRC2 control of zone keypad.
- 3** NUMBER BUTTONS - Buttons (0-9) for direct selection of channels or discs.
- 4** VOLUME UP/DOWN - Raises and lowers the volume for the room you are in, or for the selected Local Device.
- 5** CURSOR KEYS - Issues IR commands for source equipment, allowing movement through menus and program screens.
- 6** COMMAND KEYS - Controls the selected device (e.g., VCR, DVD, or CD player) with these buttons.
- 7** SOURCE - Directly select sources connected to the Russound controller while in the Russound mode.
- 8** F1 AND F2 BUTTONS - Selects and saves Favorite 1 or Favorite 2 preset selections.
- 9** INPUT - Scrolls through sources while in the Russound mode, or switches inputs on selected Local Source.
- 10** LOCAL DEVICE BUTTONS - Selects Local Source to be controlled by SRC2.
- 11** SETUP - Use for programming SRC2 using the built-in library or by learning-in codes.



USER OPERATION

UNO-S2 Keypad Button Functions

Room On/Off

Press and release  to turn on the UNO System Keypad. This also turns on the corresponding CAV6.6's room, and any presets previously assigned will be activated, including settings for bass, volume, last source selected, etc. Press and release  to turn off the UNO System Keypad. This will also put the corresponding CAV6.6's room into a standby state.



System All On/Off

An "All On" command is issued by pressing  and holding for 3 seconds, after an initial room has been turned on. An "All Off" command can be issued to all rooms by pressing and holding  after the room has been turned off.

System On Indicator

When the room is off, but the system is on in another room,  is illuminated by a green backlight and the "SYS ON" icon remains visible.

Source Select Button







 scrolls through the six A/V source inputs and the Aux source. To change sources, press and release . As the sources are sequentially selected, each source's name appears on the keypad LCD panel. When a source is selected in more than one room, the "SHARED" icon will appear on all UNO Keypads using that source.

 is also used to enter the User Menu with a press and hold action. (See next page for User Menu)

Volume Up/Down Buttons

The room's audio output is adjusted using .

F1 and F2 Buttons

The  and  buttons are user favorite presets. These presets can be selected at any time to recall source selection, volume, and favorite channel, disk, etc. To store a favorite preset: first, adjust the room settings and select a source to be stored. Next, press and hold the desired  or  button until SAVED is displayed on the LCD panel. Now a press and release of the button will recall the favorite preset. To set a favorite numbered disk or channel, use  or  to select a disk or channel (e.g., channel 45). Wait for the keypad to show the source name, then press and hold the F1 or F2 within 15 seconds of setting the numeric selection to save the setting.

Command Keys



The command keys allow control of the selected source at the UNO Keypad. The command keys are activated with a press and release, or press and hold to access secondary functions.







UNO-S2 User Menu - Setting Preferences









The User Menu allows the user to adjust the audio properties and control functions of a particular room.

The following keys are used to navigate and make changes while using the User Menu:

To enter the User Menu, press and hold  during normal operation. To exit the User Menu, press and release .

-  Adjust feature setting (increment).
-  Adjust feature setting (decrement).
-  Go to next feature.
-  Go to previous feature.
-  View current feature setting.

The following features make up the User Menu:

BASS  TREBLE  LOUDNESS  BALANCE
 TURN ON VOL  BG COLOR  DO NOT
 DSTRB  PARTY MODE  FRONT A/V IN 

Feature and Setting:

- 1. BASS**
-10 < Bass:Flat > +10
- 2. TREBLE**
-10 < Treble:Flat > +10
- 3. LOUDNESS** (more bass, fuller sound)
On or Off
- 4. BALANCE**
Left -10 < Center > Right +10
- 5. TURN ON VOL** (default room volume level)
0 to 100
- 6. BG COLOR** (keypad background light)
Amber or Green or Off

7. DO NOT DSTRB - On or Off (default)

Do Not Disturb means do not disturb this room or selected source. This stops pages from being sent to this room, stops an "All Off," "All On" or Party Mode command from affecting this room.

When another UNO Systems Keypad selects the same source, a DND icon will appear alerting the user the source is in Do Not Disturb mode.

8. PARTY MODE - Master (Enable) or Off (Disable)

When in "PARTY MODE" the system is primarily controlled by a "MASTER" keypad. Party Mode links all rooms to the same source which is selected by the Master Keypad room. Any keypad in the system can become a Master keypad (if enabled) but only one Master Keypad may exist at a time in Party Mode. Selecting Master keypad mode from another keypad will transfer Master keypad control to that room and release it from the first. When the source selected in the Master keypad room is changed then the source for all rooms changes as well.

Volume level changes at the Master Keypad will be reflected in all rooms in Party Mode. Non-Master rooms in Party Mode can temporarily override Master Keypad volume level adjustments for their particular room preference. F1 and F2 favorite presets selected from the Master Keypad will be enabled in all rooms in Party Mode. Master Keypad will not change Bass, Treble, or Loudness adjustments for any other rooms other than the Master Keypad room. Every other keypad will still operate its respective bass, treble, balance and loudness adjustments for that room.

9. FRONT (AUX) A/V IN - Enabled or Disabled



Allows the system to select a seventh source option through the controller's front panel AUX connection for use with camcorders, game consoles, etc.

USER OPERATION



UNO-S1 Keypad Button Functions

The UNO-S1 keypad operates in a similar manner as the UNO-S2 keypad.

Room On/Off

Press and release  to turn on the UNO System Keypad. This also turns on the corresponding CAV6.6's room, and any presets previously assigned will be activated, including settings for bass, volume, last source selected, etc. Press and release  to turn off the UNO System Keypad. This will also put the corresponding CAV6.6's room into a standby state.



System All On/Off

An "All On" command is issued by pressing  and holding for 3 seconds, after an initial room has been turned on. An "All Off" command can be issued to all rooms by pressing and holding  after the room has been turned off.

System On Indicator

When the room is off, but the system is on in another room,  is illuminated by a green backlight and the "SYS ON" icon remains visible.

Source Select Button

 scrolls through the six audio source inputs. To change sources, press and release . As the sources are sequentially selected, each source's name appears on the keypad LCD



panel. When a source is selected in more than one room, the "SHARED" icon will appear on all UNO Keypads using that source.  is also

used to enter the User Menu with a press and hold action. (See next page for User Menu)

Volume Up/Down Buttons

The room's audio output is adjusted using .





Command Keys

The command keys   allow control of the selected source at the UNO Keypad. The command keys are activated with a press and release, or press and hold to access secondary functions.

UNO-S1 User Menu - Setting Preferences

The UNO-S1 User Menu allows the user to adjust the audio properties and control functions of a particular room.

To enter or exit the User Menu, press and hold  during normal operation. The following keys are used to navigate and make changes while using the User Menu:

-  Press and hold to adjust feature setting (increment)
-  Press and hold to adjust feature setting (decrement)
-  Go to next feature.
-  Go to previous feature.
-  View current feature setting.

UNO-S1 User Menu

Note: When within the UNO-S1 User Menu, if no keys are pressed, the display will revert back to its runtime display.

The following features make up the User Menu:

Bass  Treb  Loud  Bal  OnVol 
 Bkgnd  DND  Party  FrtAV 

Feature and Setting:

1. **Bass** -10 < Bass:Flat > +10
2. **Treb (Treble)** -10 < Treble:Flat > +10
3. **Loud (Loudness)** (more bass, fuller sound) On or Off
4. **Bal (Balance)** Left 10 < Center > Right 10
5. **OnVol (Turn on Volume)** (default room volume level) 0 to 100 (in steps of 2)
6. **Bkgnd (Background Color)** (keypad background light) Amber or Green or Off
7. **DND (Do Not Disturb)** - On or Off (default)

Do Not Disturb means do not disturb this room or selected source. This stops pages from being sent to this room, stops an "All Off," "All On" or

Party Mode command from affecting this room. When another UNO Systems Keypad selects the same source, a DND message will scroll on the the LCD panel, alerting the user the source is in Do Not Disturb mode.

8. Party (Party Mode) - Master or Off

When in "PARTY MODE" the system is primarily controlled by a "MASTER" Keypad. Party Mode links all rooms to the same source which is selected by the Master Keypad room. Any keypad in the system can become a Master Keypad (if enabled) but only one Master Keypad may exist at a time in Party Mode. Selecting Master Keypad mode from another keypad will transfer Master Keypad control to that room and release it from the first. When the source selected in the Master Keypad room is changed then the source for all rooms changes as well. The keypad will scroll a PARTY message on the LCD panel. It will scroll a MASTR message in lieu of PARTY if Master is enabled.

Volume level changes at the Master Keypad will be reflected in all rooms in Party Mode. Non-Master rooms in Party Mode can temporarily override Master Keypad volume level adjustments for their particular room preference. Master Keypad will not change Bass, Treble, or Loudness adjustments for any other rooms other than the Master Keypad room. Every other keypad will still operate its respective bass, treble, balance and loudness adjustments for that room.

9. FrtAV (Front A/V Aux In) - Enabled/Disabled

Allows the system to select a seventh source option through a controller's front panel AUX connection for use with camcorders, game consoles, etc.

USER OPERATION

UNO-TS2 Touchscreen Button Functions

Room On/Off

To turn on the room and the touchscreen, touch the UNO-TS2 screen anywhere, or press and release the power button. Any presets previously assigned will be activated, including settings for bass, volume, last source selected, etc. Press and release the power button to turn off the touchscreen, and to put the room into a standby state.

System All On/Off

An "All On" command is issued by pressing the power button and holding for 3 seconds, after an initial room has been turned on. An "All Off" command can be issued to all rooms by pressing and holding the power button after the room has been turned off.

System On Indicator

When the room is off, but the system is on in another room, the power button is illuminated by a red backlight.

Volume Up/Down Buttons

The room's audio output is adjusted using the volume up/down hard buttons on the side of the touchscreen.

F1 and F2 Buttons

The F1 and F2 buttons are user favorite presets. These presets can be selected at any time to recall source selection, volume, and favorite channel, disc, etc. To store a favorite preset: first, adjust the room settings and select a source to be stored. Next, press and hold either F1 or F2 until "SAVED" is displayed on the LCD panel. Now a press and release of the button will recall the favorite preset. To set a favorite numbered disc or channel, use Plus or Minus to select a disc or channel from its source screen. Wait for the touchscreen to show the source name, then press and hold F1 or F2 within 15 seconds of setting the numeric selection.

Source Select Button

The six buttons in the middle of the touchscreen's home page show the six assigned names of the sources. To select a source, press the button assigned to that source. To change sources, return to the home screen and press another source button. As the sources are selected, each source's name appears on the touchscreen's LCD panel. When a source is selected in more than one room, the "shared" icon will be lit on all UNO Keypads using that source.

Source Control Screens

As each source button is pressed, a different screen appears that is customized to the source. These source screens come in "sets" which may have more than one screen per source that provide source information and selection options. In addition, the hard buttons on the right side of the touchscreen have secondary functions that are indicated with text on the specific source screens.



UNO-TS2 Home screen

UNO-TS2 - Setting Preferences

The Options button on the UNO-TS2 home screen brings up room setting options and screen adjustments. (For more detailed information, consult the UNO-TS2 Instruction Manual)

Features

Turn On Volume - This sets the room's default volume when the room is turned on.

Party Mode - When in "PARTY MODE" the system is primarily controlled by a "MASTER" Keypad. Party Mode links all rooms to the same source which is selected by the Master Keypad room. Any keypad in the system can become a Master Keypad (if enabled) but only one Master Keypad may exist at a time in Party Mode.

Do Not Disturb - Do Not Disturb means do not disturb this room and selected source. This stops an "All Off" or Party Mode command from affecting this room. When another UNO Systems Keypad selects the same source, a DND icon will appear alerting the user the source is in Do Not Disturb mode.

Sound Control

Bass - Adjust the bass level for the room

Balance - Adjust the left-to-right speaker balance for the room

Treble - Adjust the treble for the room

Loudness - Turn loudness (more bass, fuller sound at "low" volumes) on or off for the room. A checkmark appears to indicate "Loudness" activation.



Options screen



Features screen



Sound Control screen

R

INSTALLER GETTING STARTED

Unpacking the Components

- Keep the original carton and packing materials for future shipment or storage.
- Check for any visible signs of damage. If you encounter any concealed damage, consult your Russound dealer before proceeding to install the unit.
- Retain the sales receipt as it establishes the duration of the limited warranty and provides information for insurance purposes.

Tools needed for installation:

- Drill with a 1/2" x 6" drill bit
- Keyhole saw
- Flat head screwdriver (medium size)
- Phillips Screwdriver (cordless recommended)
- 110 punchdown tool (included)
- Modular RJ-45 crimper and connectors
- Pair of diagonal cutters or wire strippers
- Stud finder
- Steel wire fish tape
- Cable staples
- PLASTIC double-gang electrical work boxes

System Installation Considerations

There are several factors to consider before installing the Russound CAV6.6 controller:

- What are the intended listening zones, and what zones require audio and video distribution or audio only?

- Are A-BUS[®] sub-zones needed? A-BUS sub-zones are only available for zones 1 - 4. The A-KP2 amplified keypad can provide direct source selection for only the first four sources when in 'Multi' source mode.
- What system options and accessories might be required for features such as paging, local sources, etc.?
- From where in each zone will the user prefer to control the system? Where will the keypads be located? Where will the speakers be located?
- Where will the source equipment be located? The CAV6.6 must have proper ventilation above and below for air circulation and heat dissipation. A rack-mount location may require fans and vents.

Connection Tips

- It is recommended that the CAV6.6 and the source equipment be plugged into a dedicated 20-amp circuit with an isolated ground. A power line conditioner can reduce interference problems caused by noise found in some electrical systems.
- Disconnect all live power cords before making connections to the controller.
- Verify that all connections and polarity are correct.
- Keep all power cords away from all signal cables to prevent humming from induced noise.
- Choose reliable signal cables/patch cords.
- Label all wires with room location at both ends of the wire.



Do not connect the controller's main power feed until all other connections have been made and verified. Live connection or removal of the keypad wiring or other wiring when the system is powered can cause communication problems in the network. Double-check terminations during each phase of the installation to prevent accidental damage. Incorrect wiring is the number one cause for non-warranty product damage.



INSTALLER COMPONENT GUIDE

CAV6.6 Controller-Front Panel

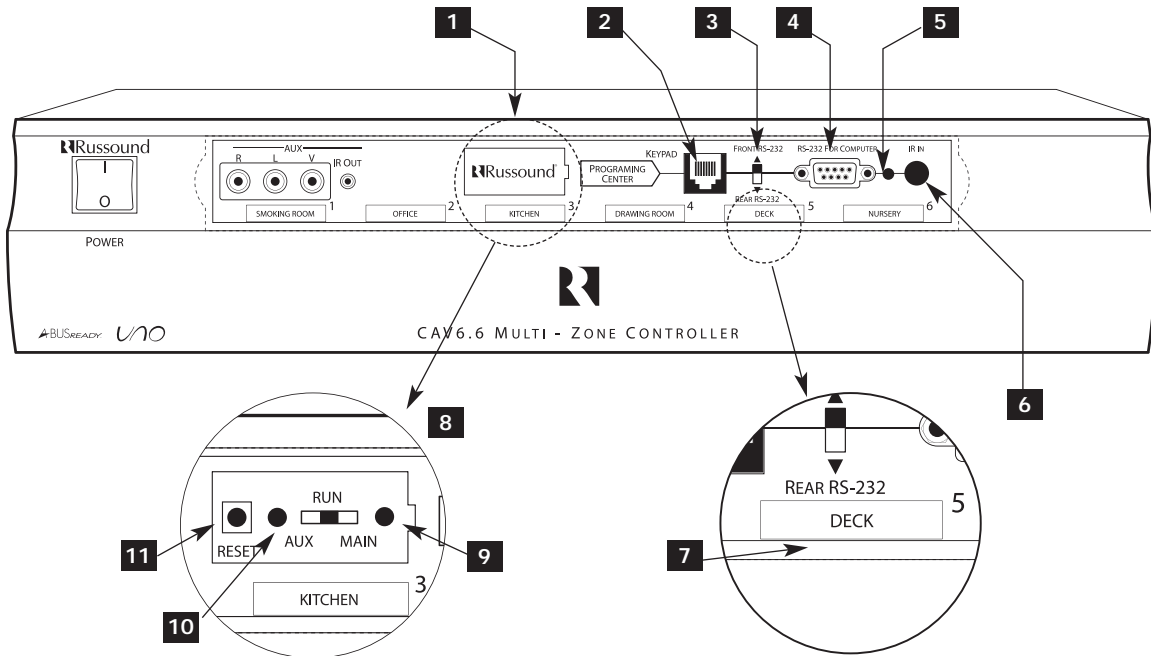

- 1** PROGRAM SELECTOR COVER - Protects the Program Selector Switch
- 2** KEYPAD PROGRAMMING PORT - Accepts an RJ-45 terminated UNO keypad for programming
- 3** FRONT/REAR RS-232 SWITCH - Selects front or rear RS-232 connection for programming
- 4** RS-232 INTERFACE - Front and rear RS-232 connections for software updates, and allows zones to be controlled by PC or other RS-232 interface devices
- 5** IR CONFIRMATION LED - IR Learning and preprogrammed IR output confirmation LED
- 6** IR RECEIVER - Receives IR signal when learning IR codes into the CAV6.6
- 7** ZONE LABEL - Selectable backlit labels identify active zones
- 8** OS PROGRAM SELECTOR SWITCH - Selects either Main or Aux IC when updating OS software
- 9** MAIN LED - Illuminates when the Main Micro-Controller IC is selected to be programmed
- 10** AUX LED - Illuminates when the AUX IC is selected to be programmed
- 11** RESET BUTTON - Resets the CAV6.6 when OS updates are completed

INSTALLER COMPONENT GUIDE

CAV6.6 Controller-Rear Panel

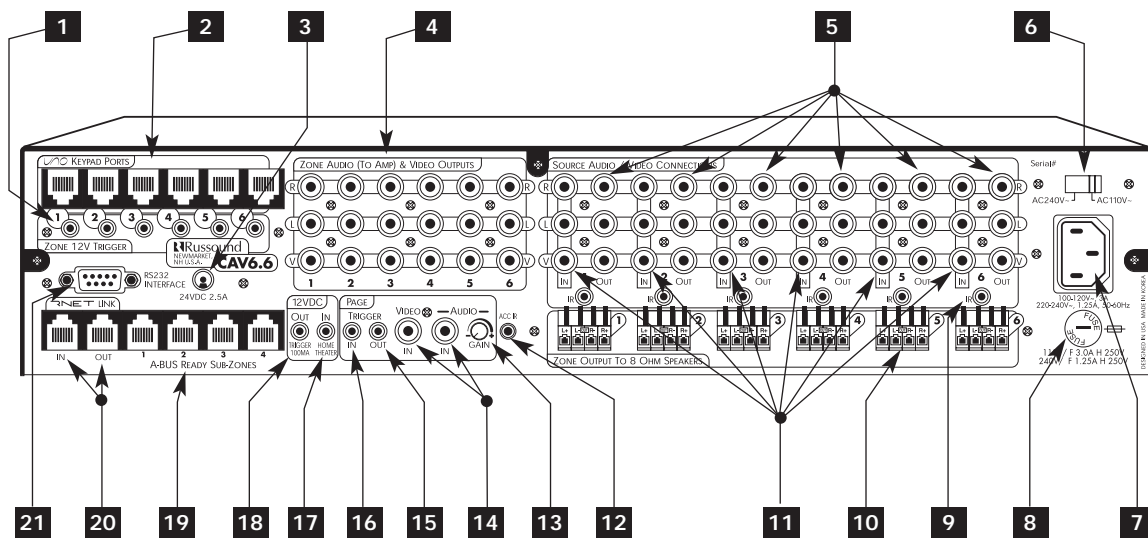

- 1** ZONE 12VDC TRIGGER OUT - 12VDC 50ma is available whenever the corresponding zone is turned on
- 2** UNO KEYPAD PORTS - One UNO Keypad Port for each of the six CAV6.6 Zones
- 3** 24VDC 2.5A INPUT - Provides power to the A-BUS READY SUB-ZONES when used with a 24VDC 2.5A power supply (e.g., Russound A-PS)
- 4** ZONE AUDIO/VIDEO OUTPUTS - Variable line audio with fixed video, used to connect to an external amplifier and television monitor
- 5** AUDIO/VIDEO SOURCE LOOP OUTPUTS - Six sets of buffered Audio/Video Line Level Loop Output connections
- 6** AC 240V-AC 110V Switch - Switches A/C input Voltage between 110VAC and 240VAC
- 7** AC 120/240 INPUT - Grounded 3-terminal plug detachable power cord connection for the CAV6.6
- 8** FUSE HOLDER - Holds a replaceable fuse for A/C input connection
110VAC operation-F 3A H 250V, 240VAC operation-F 1.25A H 250V
- 9** SOURCE IR OUTPUTS - Six routed source-specific IR Output jacks allow for IR control of source equipment

INSTALLER COMPONENT GUIDE

CAV6.6 Controller-Rear Panel

- 10** SPEAKER OUTPUTS - Connect 8 Ohm speakers for each zone by using detachable color-coded modular snap connectors
- 11** AUDIO/VIDEO INPUTS - Six sets of Audio/Video Line Level input connections for CAV6.6 source components
- 12** ACC IR OUTPUT - ACC IR Output jack will pass all IR signals from all keypads
- 13** PAGE LINE LEVEL AUDIO GAIN CONTROL - Adjusts the Line Level Audio Page Input
- 14** PAGE A/V INPUTS - RCA jacks allow for one Audio/Video Page Input. Signal sensing is used on Page Audio In to initiate a page
- 15** PAGE 12VDC TRIGGER OUT - Page Trigger Out supplies 12VDC whenever 12VDC is applied to the Page 12VDC Trigger In
- 16** PAGE 12VDC TRIGGER IN - Applying 12VDC to the Page 12VDC Trigger In jack will activate Audio/Video Page for assigned CAV6.6 Zones and initiate a page (overrides signal sense)
- 17** HOME THEATER 12VDC TRIGGER IN - 12VDC input jack notifies the CAV6.6 that additional A/V components are active, e.g., home theater equipment
- 18** 12VDC TRIGGER OUT - 12VDC 50ma Trigger Out turns on when any zone is on
- 19** A-BUS READY SUB-ZONES - A-BUS Amplified Control Modules and Hubs can be added for additional sub-zones of audio (Zones 1 to 4 only)
- 20** RNET LINK IN AND LINK OUT - Links multiple CAV6.6's, also links future Russound components that are RNET compatible
- 21** RS-232 INTERFACE - The RS-232 Interface on the rear and on the front, allows the zones to be controlled by PC or other devices that have an RS-232 Interface. The RS-232 Interface also allows for software updates and programming

INSTALLER COMPONENT GUIDE

UNO Keypad-OS Update Port

Software Update

If a keypad update is released, it will be available online at www.russound.com through the Document Center, under RNET Systems. Before starting the update procedure, download updates to a PC and connect the correct programming cable from the PC to the OS update port on the front of the keypad.

Required Russound Cable for Programming UNO-S2, UNO-TS2

- use Programming Cable P/N 2500-121036

UNO-S1

- use Advanced Programming Cable P/N 2500-521065
(Do not put RS-232 level signals into the pins)

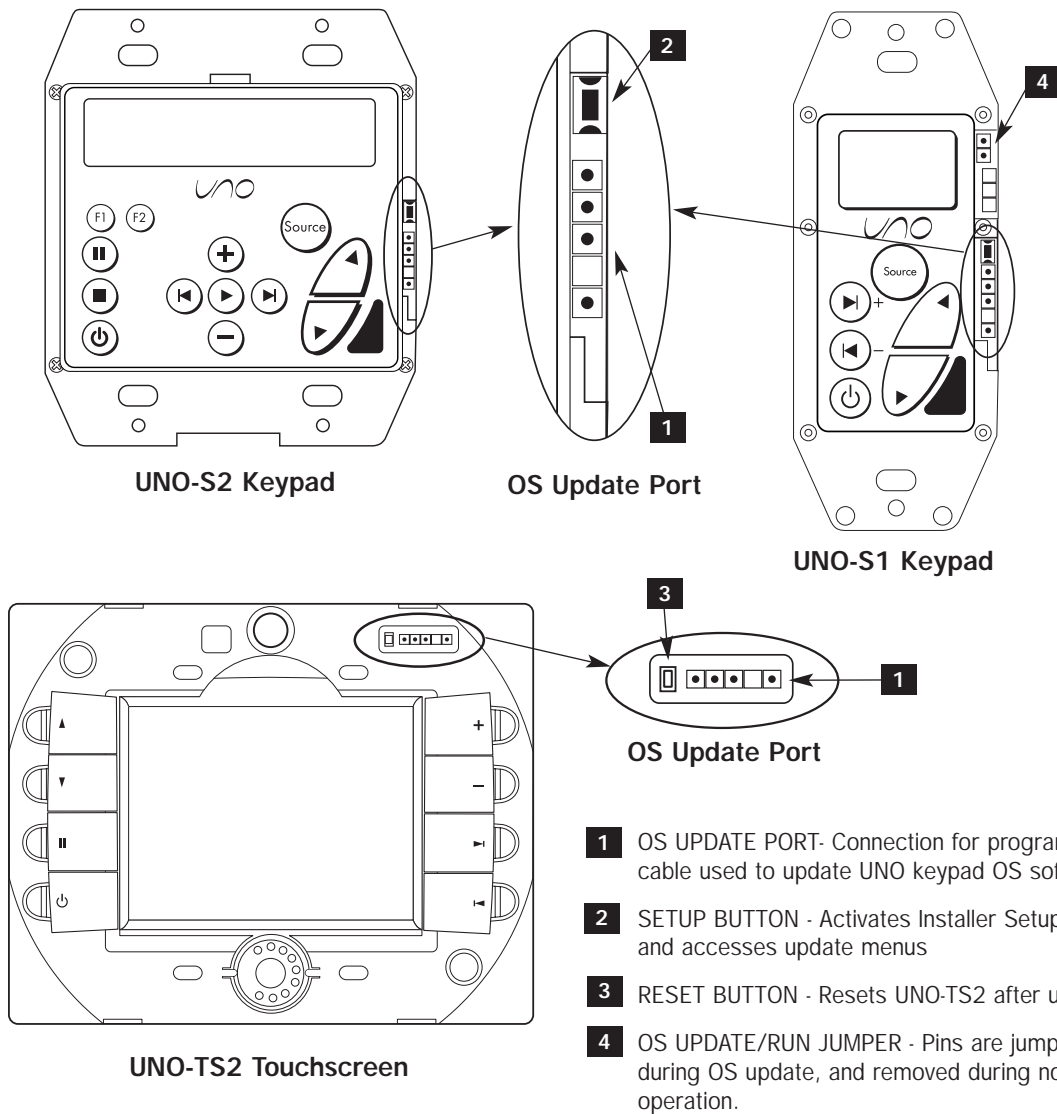

INSTALLER COMPONENT GUIDE

UNO Keypads-Rear Panel

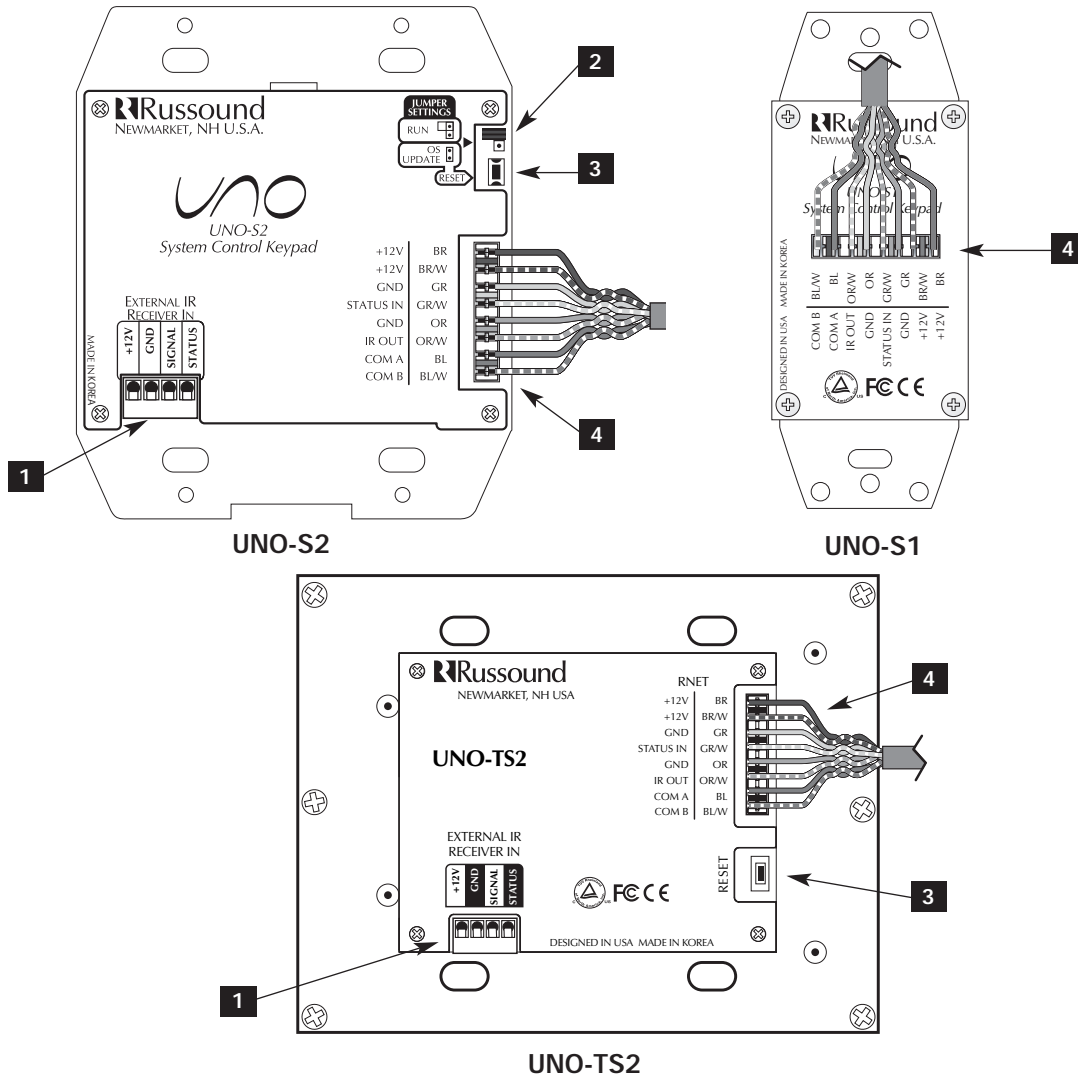

- 1** EXTERNAL IR RECEIVER IN CONNECTOR - Connection for an external IR Receiver
- 2** OS UPDATE JUMPER - Selects "Run" or "OS Update" mode
- 3** RESET BUTTON - (UNO-S2) Reset whenever changing from RUN to OS update (UNO-TS2) Reset after touchscreen firmware update
- 4** 110 PUNCHDOWN CONNECTOR - Termination for CAT-5 connection between the UNO Keypad and the CAV6.6 controller

INSTALLER WIRING INSTRUCTIONS

RJ-45 Connections

The CAT-5 T568A wiring standard shown on the right is used for the RJ-45 terminations.

RJ-45 Connection Details

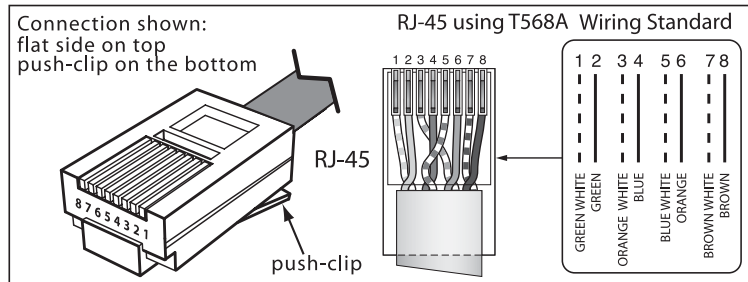

Keypad Wiring

For the UNO keypads, the following connections are used to terminate the CAT-5 wire to the 110 punchdown on the keypad:

<u>CAT-5 WIRE COLOR</u>	<u>TYPE</u>
Brown	+12V
Brown/White	+12V
Green	Ground
Green/White	Status In
Orange	Ground
Orange/White	IR Out
Blue	COM A
Blue/White	COM B

- To determine the amount of CAT-5 wire required for the system installation, first decide how many keypads will be used, then determine the distance between each intended keypad location to the intended CAV6.6 location. The maximum recommended wire run length is 250 feet for each UNO Keypad.
- Make sure that the entire wire path between keypads and CAV6.6 is clear and not obstructed by a floor ceiling joist, or masonry wall which can't be drilled through.

- Confirm ahead of time that you can drill an outlet hole easily and in an unobtrusive spot to connect wires with the CAV6.6.
- Label wires with keypad and room location. This simplifies CAV6.6 hook-up once the keypads and speakers are installed.
- If you plan to use an additional IR receiver with an UNO keypad, first determine the location of the IR receiver, then measure the distance from the intended location to the UNO keypad location. Incorporating optional IR receivers will require additional wire. Consult the selected IR receiver model's manual for the specific wire needs.

Speaker Wiring

- Standard 16-gauge 4-conductor stranded speaker wire can be run up to to 125 feet; 14-gauge wire can be run up to 250 feet.
- When running wire, pay particular attention to the following areas:
 - Avoid locations concealing pipes, heating ducts and AC wiring in the general vicinity.
 - Avoid running wires close to house electrical wiring for any distance. If you have to run them parallel, make sure to space the wires at least two feet from the AC line.

INSTALLER

UNO-S2 KEYPAD-INSTALLATION

UNO-S2 Keypad Connections

CAT-5 Connection

The UNO-S2 Keypad uses a 110-punchdown terminal to provide a simple installation and strong connection for CAT-5 cable's eight conductors. Punchdown terminals require the use of a punchdown tool which has been provided with the keypad kit. Attach the CAT-5 cable to the 110 punchdown terminal on the UNO-S2 Keypad as shown, matching the conductor colors to the connection color guide. The keypad will not operate properly if the terminations deviate from the required connection order.



Caution:

Take care when using an impact 110 punchdown tool, as this may overspread the contact points.

Use of the impact tool may propel stray bits of wire and jacket into the keypad's chassis and possibly cause a short in the circuitry. Gently shake or blow air through the keypad chassis to remove stray wire before the keypad is installed into the junction box.

Jumper Setting

The jumper settings on the back of the UNO-S2 Keypad can be set for "Run" and "OS Update." The jumper setting must be in the "Run" position before the keypad is mounted into the junction box, and must remain set in "Run" to operate the keypad. The jumper will be set to "OS Update" only while updating the keypad's operating systems.

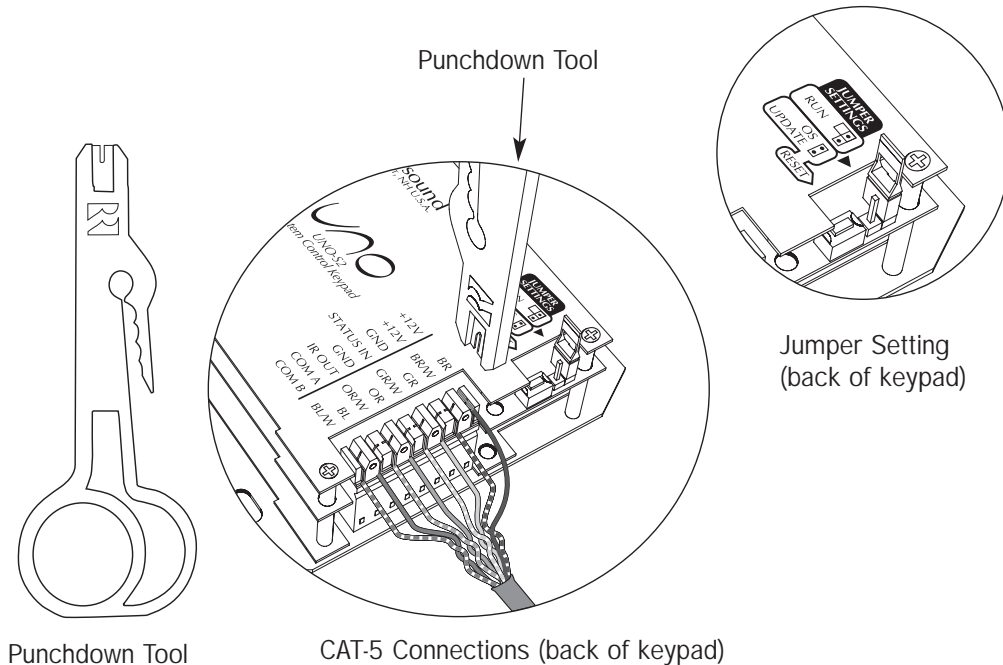

INSTALLER

UNO-S2 KEYPAD-INSTALLATION

IR Receiver Connection

The UNO-S2 keypad has an External IR Receiver In terminal for connecting an external IR receiver such as the Russound SaphIR 858, 862 Eye, or 860 Phantom. Use 2 twisted pair wire with

one pair connecting GND (GROUND) and IR (SIGNAL) and the other pair connecting ST (STATUS) and V+ (+12VDC). If the wire has a shield, connect it to ground at the UNO-S2 only.

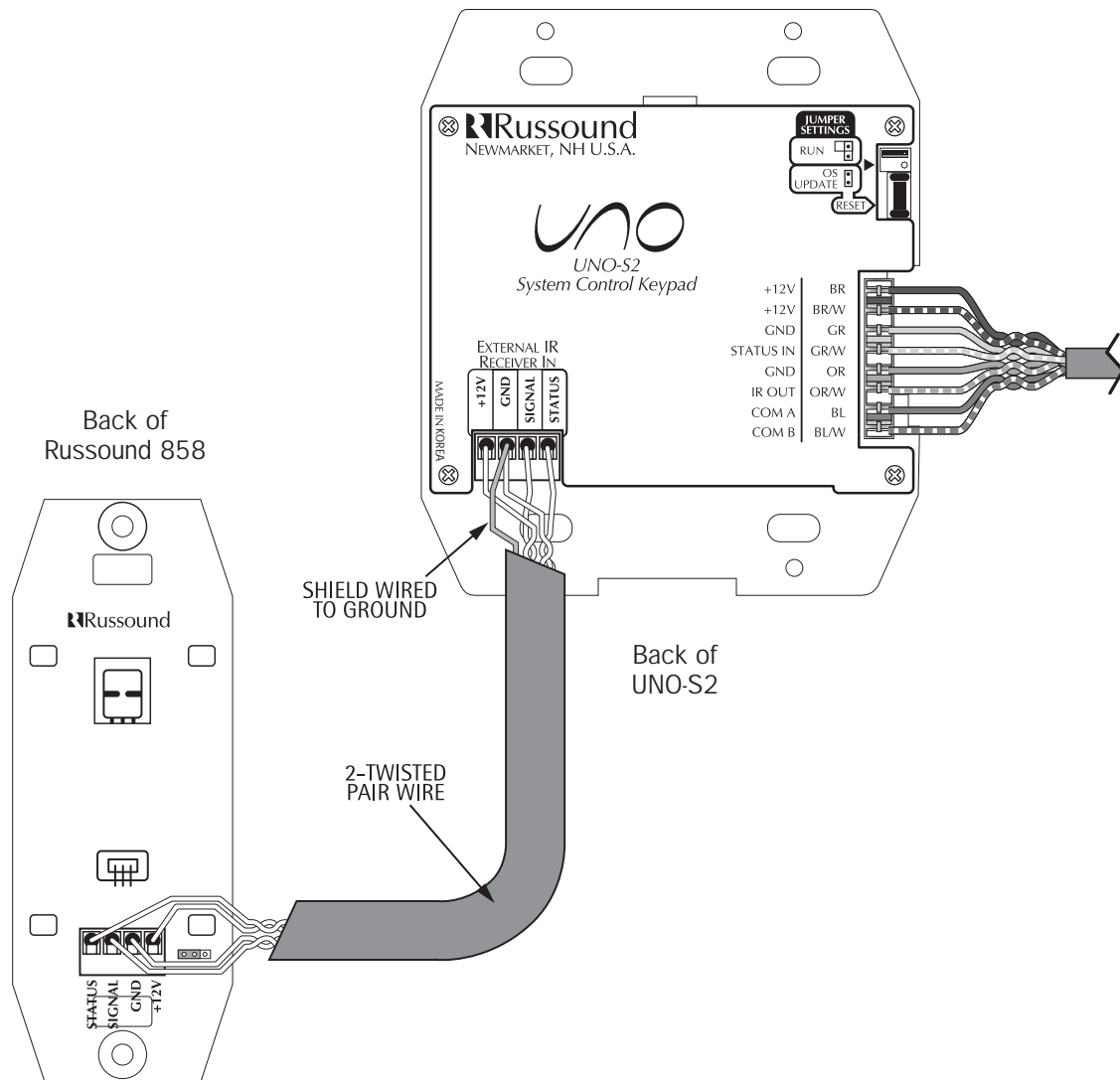

INSTALLER

UNO-S2 KEYPAD-INSTALLATION

Keypad Location

The best infrared remote performance is achieved with the keypad away from any direct sunlight, plasma TV, and low voltage lighting controls. Also consider convenience when choosing a location.

Choose a place that is easily seen from the position where a person is most likely to be located.

Check whether or not you can route the wire to the location you have chosen.

Keypad Installation

To install a double-gang keypad, you will need to use a UL/CSA approved plastic double-gang electrical box (do not use metal boxes).

- Route CAT-5 wire to the junction box from the CAV6.6.
- Use the supplied 110 punchdown tool to connect each wire to its corresponding color labeled on the punchdown terminal.
- Ensure jumper settings on keypads are in the run positions.
- Mount the keypad in the electrical box and attach the cover plate. Repeat the steps until all keypads are installed.

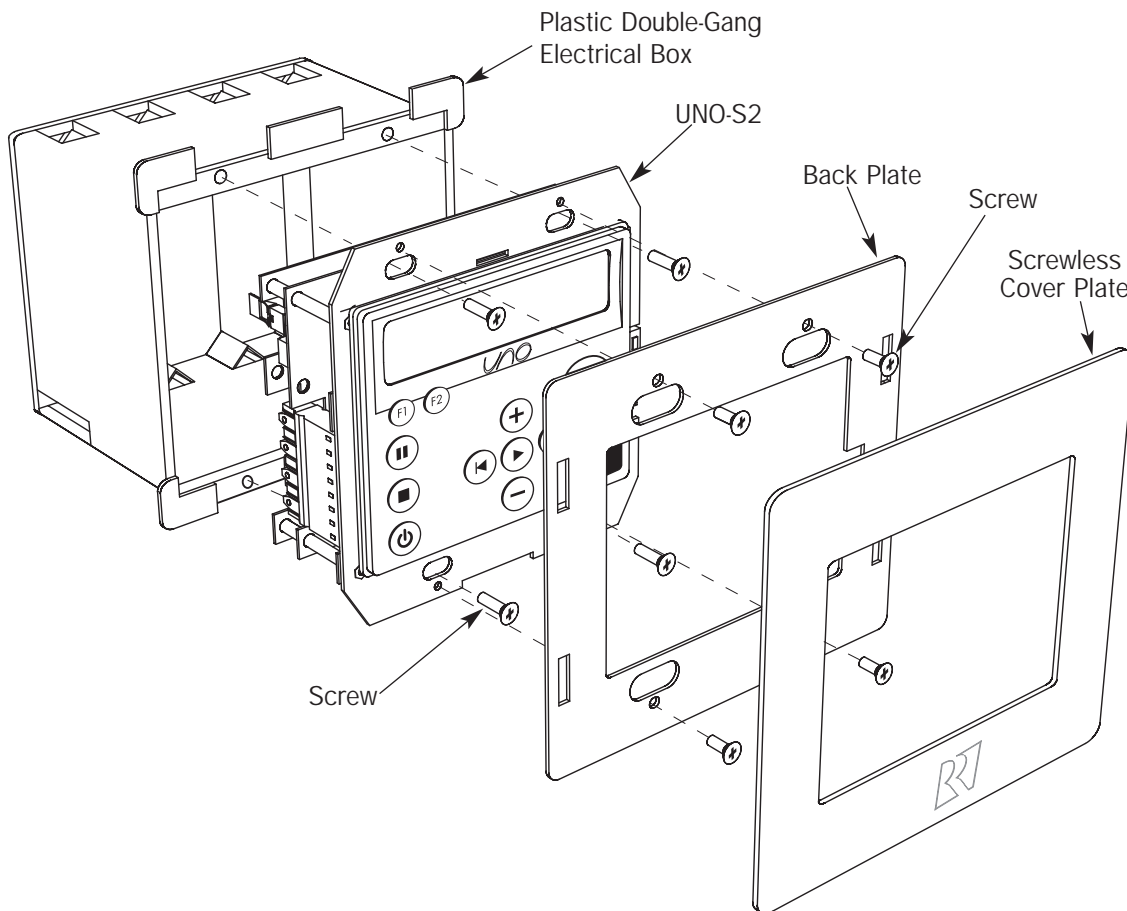

INSTALLER

MAKING CONNECTIONS

UNO System Keypad Port Connection

The UNO System Keypad Ports are located on the back of the CAV6.6 in the top left corner. Connections made at the UNO Keypad Ports are made using CAT-5 T568A RJ-45 wire configuration. CAT-5 is color-coded for ease of installation. For a clean installation when wiring from an UNO System Keypad Port use an RJ-45 CAT-5 patch cable to connect from the keypad port to an RJ-45 Wall Plate (optional). Using the same CAT-5 T568A RJ-45 wiring configuration, use

CAT-5 from the RJ-45 Wall Plate to the keypad. If using more than one keypad on a zone, connect a SA-ZX3 UNO System Keypad Splitter (optional) directly to the UNO System Keypad Port instead of going through the wall plate. Always use the CAT-5 T568A RJ-45 wire configuration when wiring any of the UNO System Keypad Ports. (See *Sample System Configuration 3*, page 84)

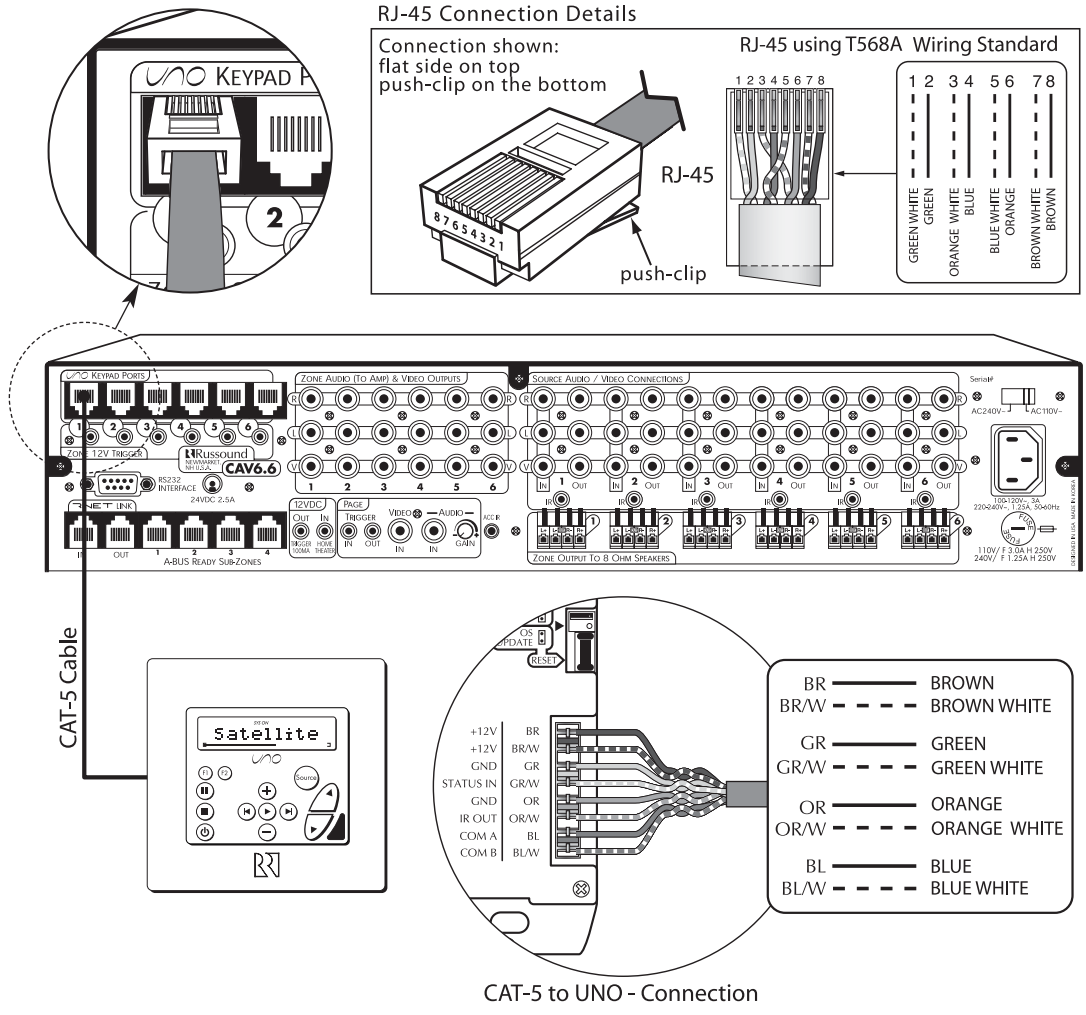

INSTALLER MAKING CONNECTIONS

Source Audio/Video Input Connections

The CAV6.6 supports up to six audio/video sources. The Source Inputs are located at the back panel. Connect each source output using quality RCA signal cables. Connect the Video, and the Left and Right Audio outputs from each source to the corresponding inputs on the CAV6.6 controller. Label each cable with the name of the selected source and the Source Audio/Video input number located on the CAV6.6.

Source IR Connections

Each source component has a designated IR port on the back of the CAV6.6. This IR port is directly below the Source Audio/Video Input/Output Connections.

1. Using an IR emitter (the Russound 845.1 is recommended) attach the end of the emitter with the 1/8" plug to the IR emitter port below the source input.
2. Remove the adhesive back at the other end of the emitter and attach the emitter over the source component's IR window.
3. In order to control this source component with IR, the source must be selected at the key-pad receiving the command.

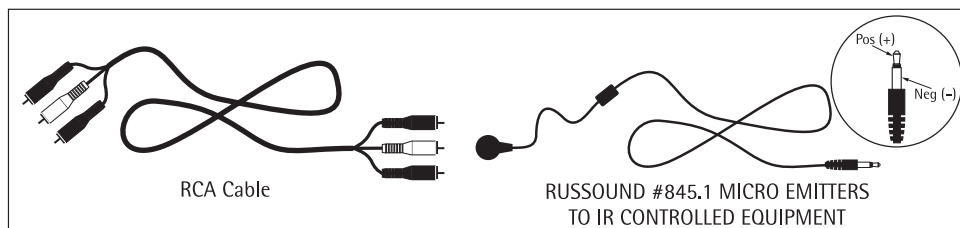
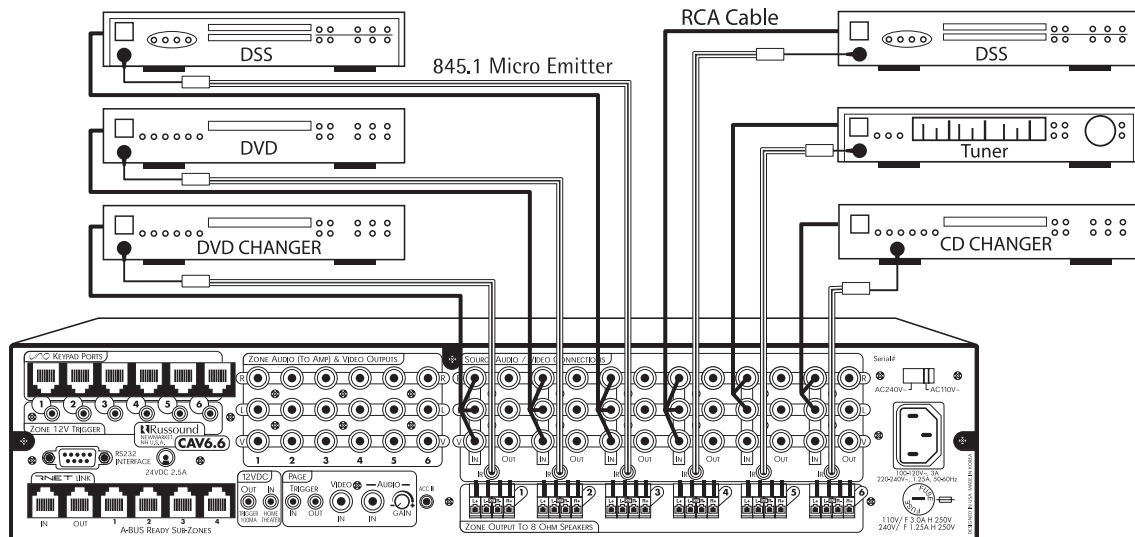

INSTALLER

MAKING CONNECTIONS

Source Audio/Video Loop Output Connections

The CAV6.6 has six buffered, fixed-level audio/video source loop outputs. This source loop configuration allows the CAV6.6 to pass source signals to another component, such as a home theater receiver or to another CAV6.6 for sharing

sources in a multiple controller system. The Source Loop Outputs are located directly to the right of the Source Audio/Video Inputs. Use quality RCA signal cables to ensure quality transference of Audio/Video signals.

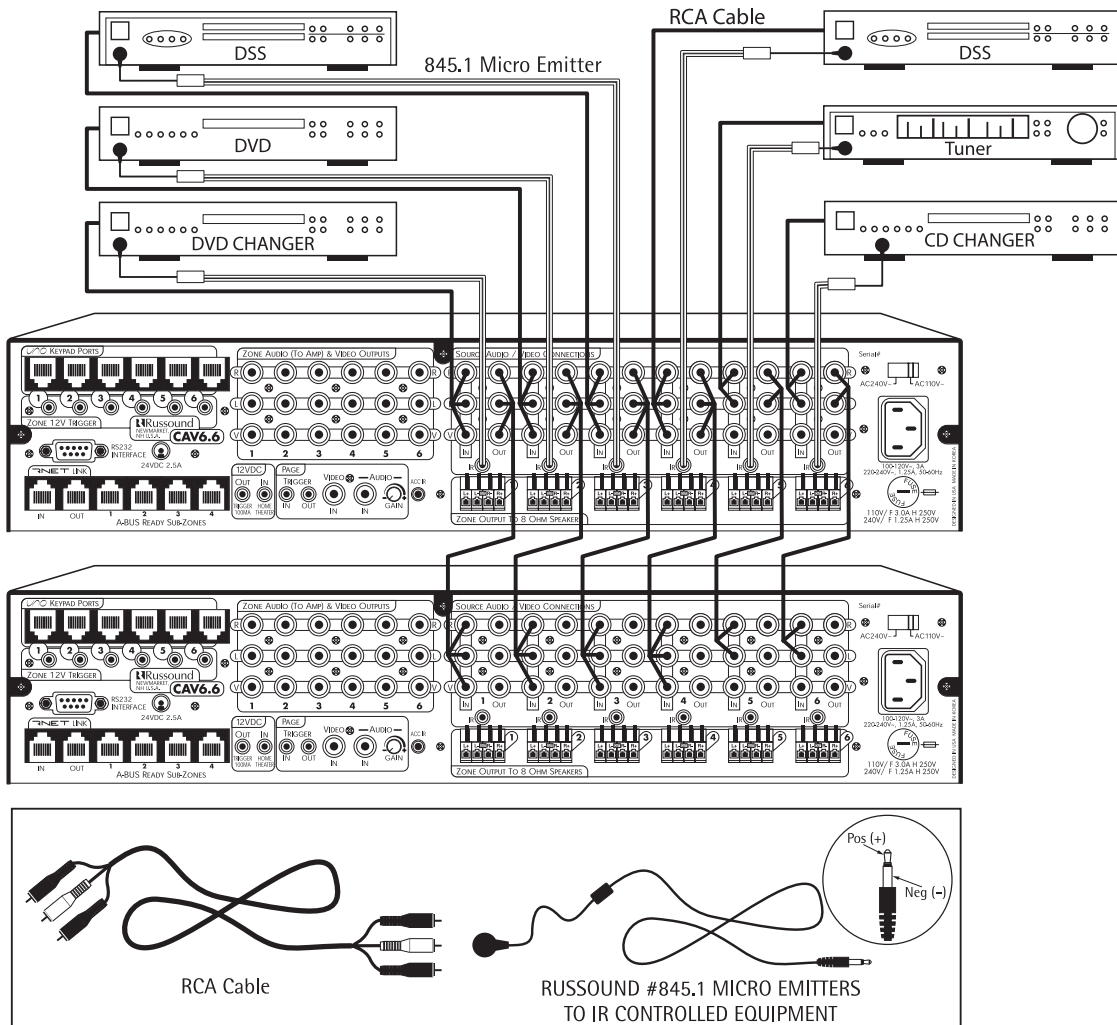

INSTALLER MAKING CONNECTIONS

Speaker Connections

The speakers are connected to the CAV6.6 using modular snap speaker connectors. Each of these color coded connectors is designated for the speaker set of a particular amplified zone. To avoid confusion, connect one zone speaker set at a time starting with Zone 1, taking care to keep zone and speaker wire identities straight. Note: An 8 Ohm minimum speaker is required for each amplified output.

1. Pull the speaker wire conductors apart so they're separated for the first two inches from their ends.
2. Using a wire stripper, remove 1/4 inch of insulation from each conductor. Twist the strands in each conductor into tight spirals.
3. Remove the modular four-color connector for Zone 1. The color code is as follows:

- WHITE -- L+ (left channel positive)**
- GREEN -- L- (left channel negative)**
- BLACK -- R- (right channel negative)**
- RED -- R+ (right channel positive)**

Lift the black lever for each connection until it locks open and insert the proper speaker wire, matching channel and polarity for all four wires. Snap the lever down. Insert the modular connector into its designated output on the back of the CAV6.6.

4. Complete the same steps for the remaining zones. Label each set of speaker wires with the zone and location.

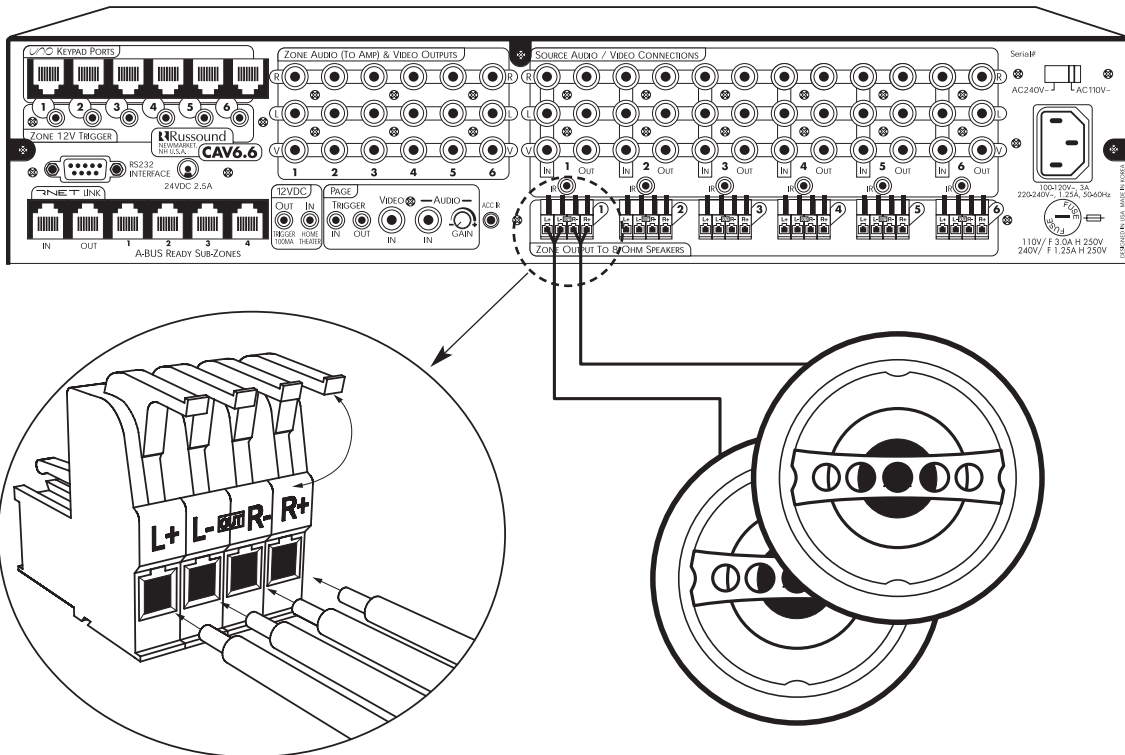

INSTALLER

MAKING CONNECTIONS

ACC IR Connection

The Accessory IR jack on the rear of the CAV6.6 allows control of any source equipment without that source being selected on the keypad. The connection for the ACC IR jack is made using an IR emitter with the 1/8" plug. The Russound

845.1 single IR emitter is recommended, or use an IR connecting block such as the Russound 857 which allows multiple units to be controlled through the ACC IR Port.

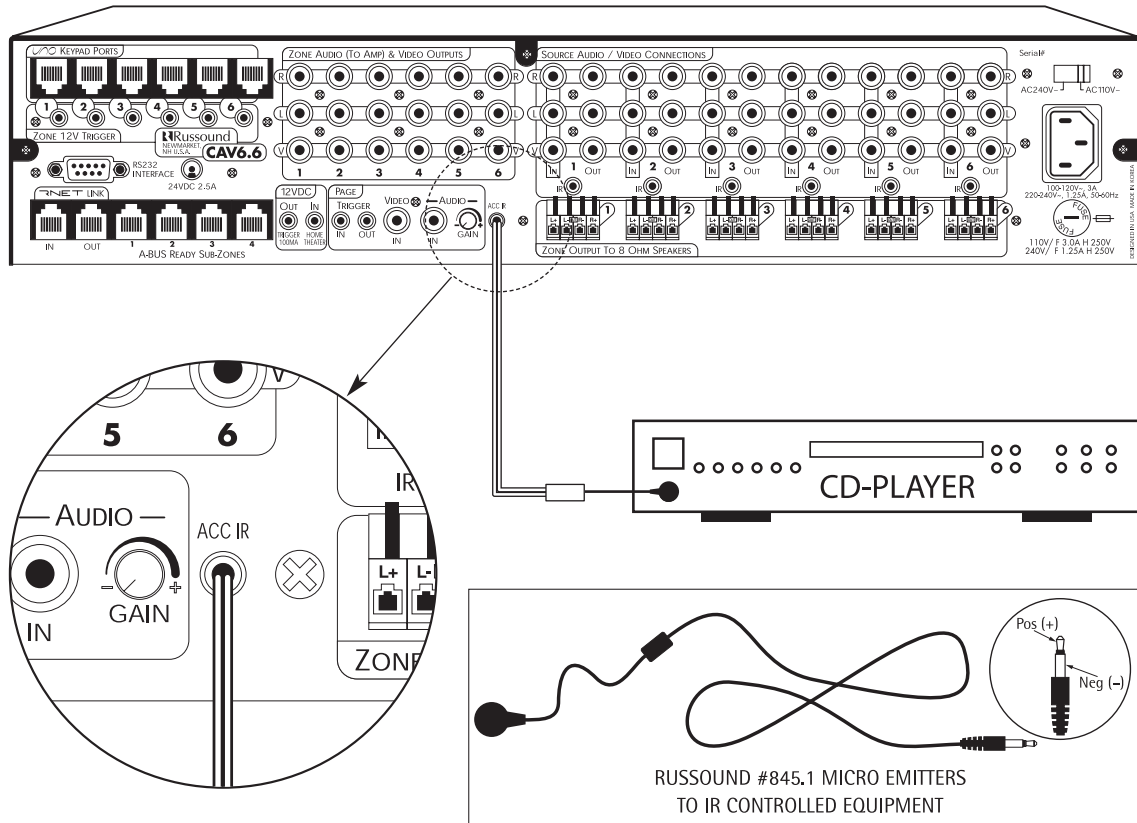

INSTALLER MAKING CONNECTIONS

Zone Audio (to Amp) and Video Outputs

The CAV6.6 has six Zone Audio/Video outputs. The Variable Audio outputs can be used if additional amplification is desired (e.g., Russound R235LS two-channel amplifier). The Zone Audio/Video Outputs are located slightly to the left of center on the rear of the CAV6.6.

Use quality RCA signal cables to ensure a constant quality Audio signal. Video for the zone will be routed via the Video connection. Use RG59 Coax Cable or an RG6 Cable with 95% copper braided shield and solid copper core up to 150 feet long for video connections to monitors.

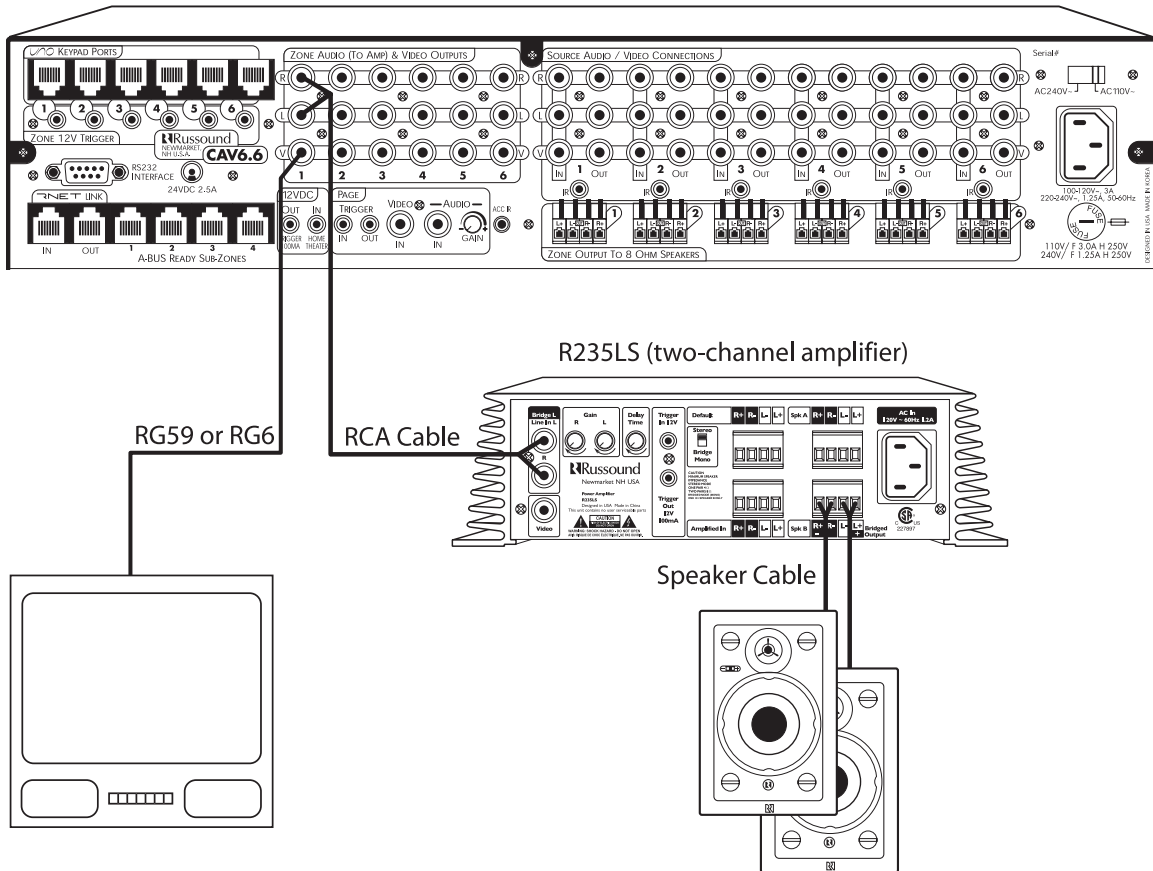

INSTALLER

MAKING CONNECTIONS

A-BUS Ready Sub-zone Connection

A-BUS products can easily expand the CAV6.6 audio system by adding A-BUS Ready Sub-zones to the first four CAV6.6 zones. The A-BUS Ready Sub-zones are located on the back of the CAV6.6 at the bottom left corner. The A-BUS Ready Sub-zones are powered by a 24VDC power supply such as the A-PS.

Use an RJ-45 CAT-5 T568A configuration patch cable to connect the A-BUS Ready Sub-zone

port to an RJ-45 wall plate (optional) for a clean installation. Using the same T568A RJ-45 wiring configuration, attach CAT-5 from the RJ-45 wall plate to an A-BUS hub or amplified control module such as the A-KP2 keypad.

If using an A-BUS hub with the A-BUS Ready Sub-zone, the hub should be located near the CAV6.6 and wired directly instead of first going through the wall plate.

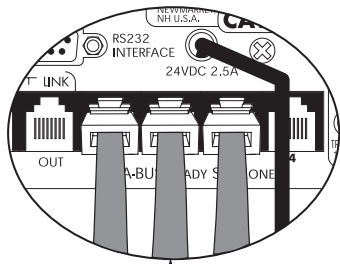

RJ-45 Connection Details

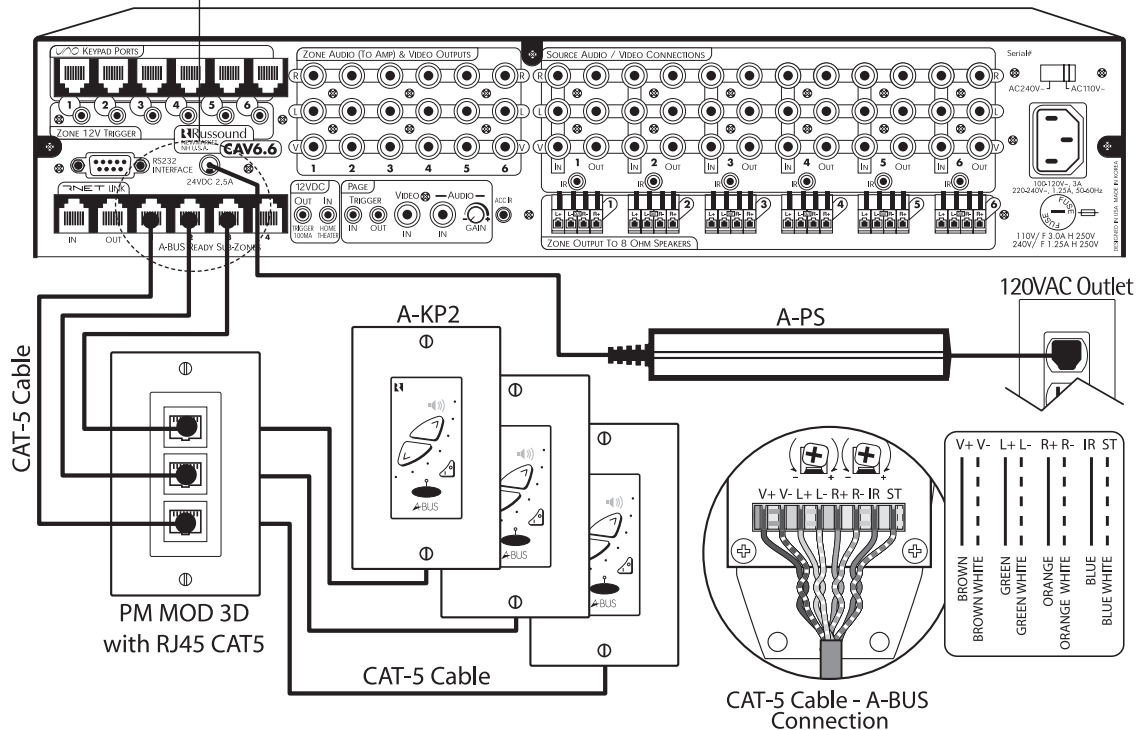
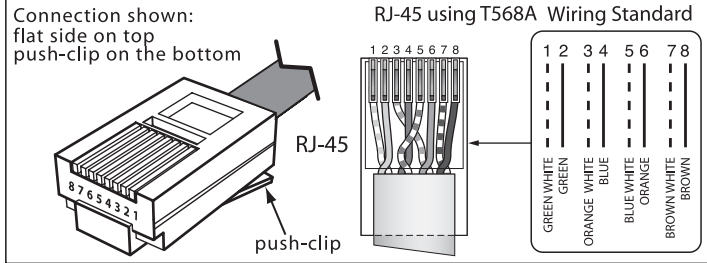

INSTALLER MAKING CONNECTIONS

12VDC Trigger In/Out

12VDC Home Theater Trigger In

This 12VDC Trigger input is used to control Power Management of the audio/video sources possibly being shared with a home theater system. When the source equipment is off and 12VDC is provided to the trigger, the sources will be turned on until it is removed. When the last zone on the CAV6.6 is turned off, 12VDC presence to the trigger input will prevent the sources from being turned off. The connections for the trigger are made using a two-conductor cable with 1/8" male mini-plug. The tip is positive (+) and the sleeve is negative (-).

12VDC 50mA Trigger Out

The 12VDC 50mA trigger out can be used to engage any 12VDC trigger device or component such as the Russound ACT-1 triggered outlet. The connections for the trigger out are made using a two-conductor cable with 1/8" male mini-plug jacks at each end. The tip is positive (+) and sleeve is negative (-).

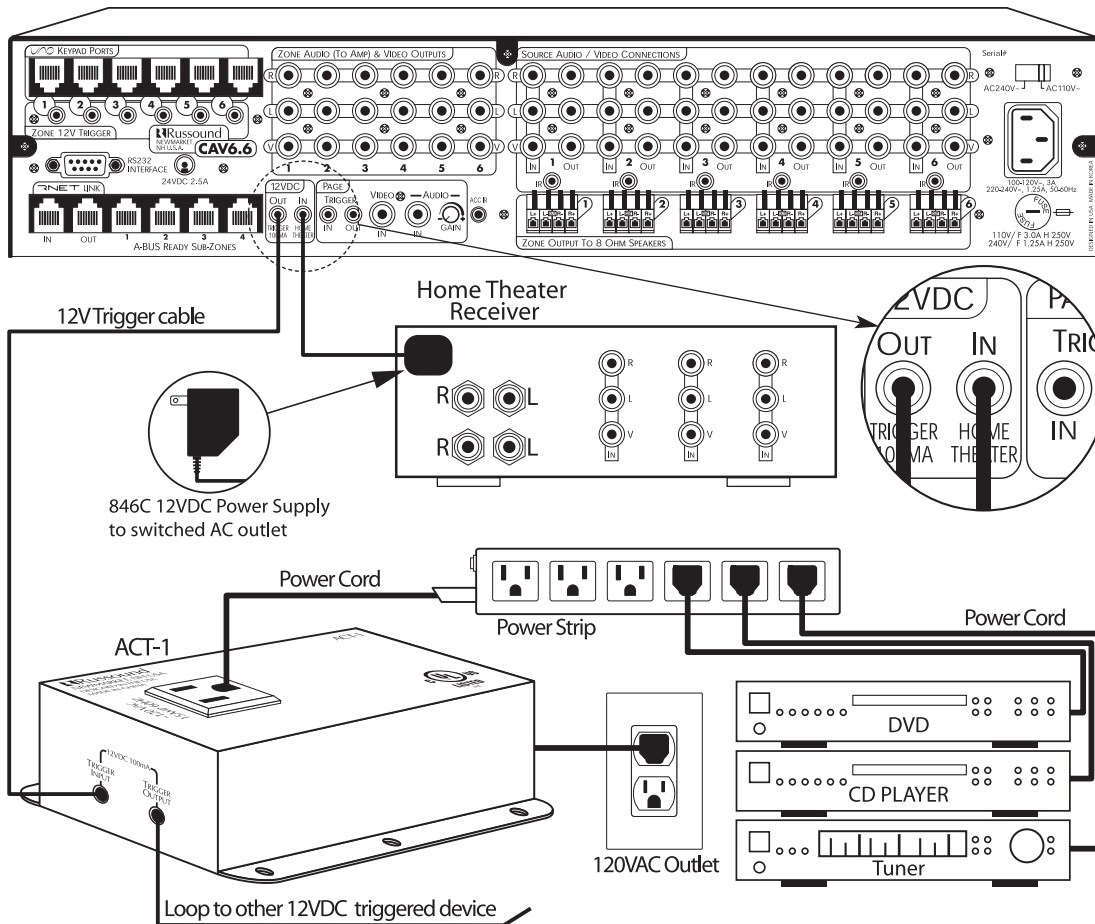

INSTALLER

MAKING CONNECTIONS

12VDC Trigger In/Out

12VDC Page Trigger In

When 12VDC is applied to the Page Trigger In, the system will page audio that is connected to the Page Audio Input and interrupt the video outputs with the page video signal. The Page Trigger In is located in the Page connection area of the CAV6.6 Controller. The connections for the trigger are made using a two-conductor cable with 1/8" male mini-plug jacks. The tip is positive (+) and sleeve is negative (-). This allows for the connection of an external paging or muting device such as the Russound DIM-1 Doorbell Interface Module. The CAV6.6 can be programmed to mute audio and video for one or all zones as preferred when the 12VDC is applied.

12VDC Page Trigger Out

Page Trigger Out 12VDC output is available under several programmable situations, such as for triggering an external amplifier, muting device or other paging component dependent on the Page Trigger In 12VDC. The connections

for the output are made using a two-conductor cable with 1/8" male mini-plug jacks at each end. The tip is positive (+) and sleeve is negative (-). The default setting for the Page Trigger Out provides 12VDC whenever 12VDC is applied to the Page Trigger In.

In some cases noise or interference may be generated by external devices that are connected to the 12 volt trigger outputs of the CAV. It may be necessary to use a ferrite bead to reduce this interference. Two to three turns of the connecting cable through the bead may be needed.

Page Audio/Video In

The Page Audio/Video Inputs accept line level audio/video signals. The paging inputs interface with the page output of a telephone, camera, or other peripheral device. Connect the audio/video signals using quality RCA cables.

INSTALLER MAKING CONNECTIONS

12VDC Trigger In/Out

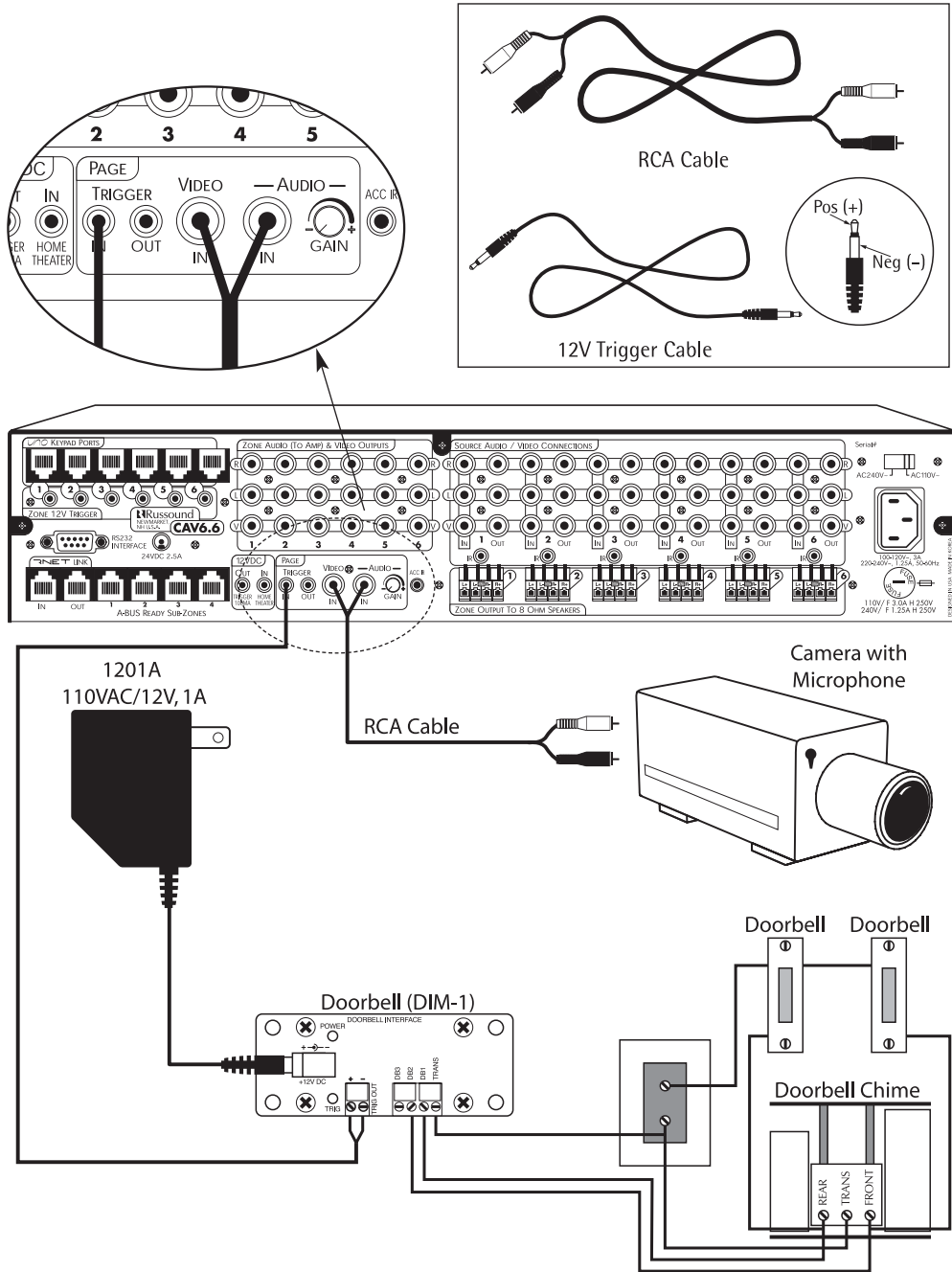

INSTALLER

MAKING CONNECTIONS

12VDC Trigger In/Out

Zone 12VDC Trigger Outputs

Zone 12VDC Triggers are located directly under the UNO Keypad Ports. The 12VDC Trigger is engaged when the corresponding zone is turned on and disengaged when the zone is turned off. The trigger can be used to engage any 12VDC trigger device or component such as the

Russound R235LS amplifier. The connections for the trigger outputs are made using a two-conductor cable with 1/8" male mini-plug jacks at each end. The tip is positive (+) and sleeve is negative (-).

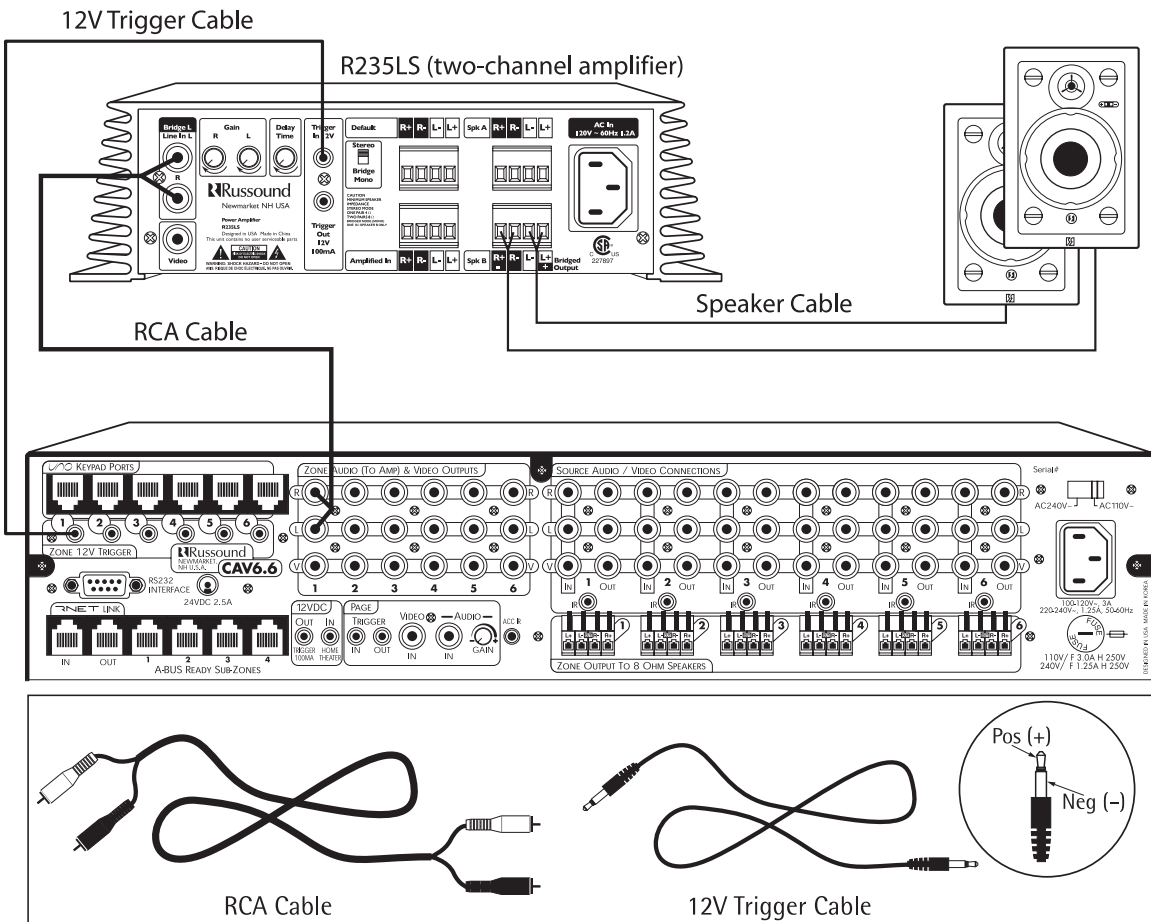

INSTALLER MAKING CONNECTIONS

RNET Link In and Link Out - Multiple Controllers

The RNET Link In and Link Out is used to connect two or more (up to 6) CAV6.6 or CAM6.6 controllers. The connection is made using a CAT-5 patch cable from the Link Out of the master controller and into the Link In of the next controller. Along with RNET data signals, the RNET Link In and Link Out jack passes the six source IR signals. The CAT-5 patch cable should not exceed 18 inches in length to avoid potential cross-talk between the source-specific IR repeating signal lines. These are only for source-specific IR remote repeating, not codes initiated from the controller's internal IR library.

Note: If two or more CAV6.6 controllers will be connected using the RNET Link In and Link Out ports, each controller must have a unique Controller ID (see **Controller Setup - Flow Chart on page 68**) prior to being connected through the RNET ports. The Controller ID assignment must be performed during the Controller Setup section of the Installation menu.

Controller #1 is always the LAST controller to be powered on in a multi-controller system.

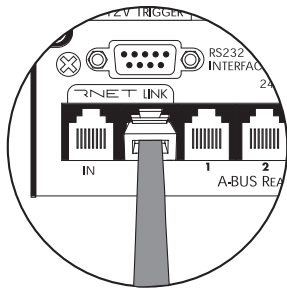

RJ-45 Connection Details

Connection shown:
flat side on top
push-clip on the bottom

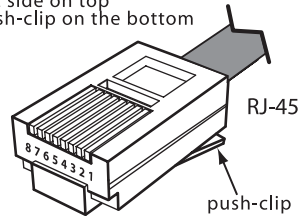

RJ-45 using T568A Wiring Standard

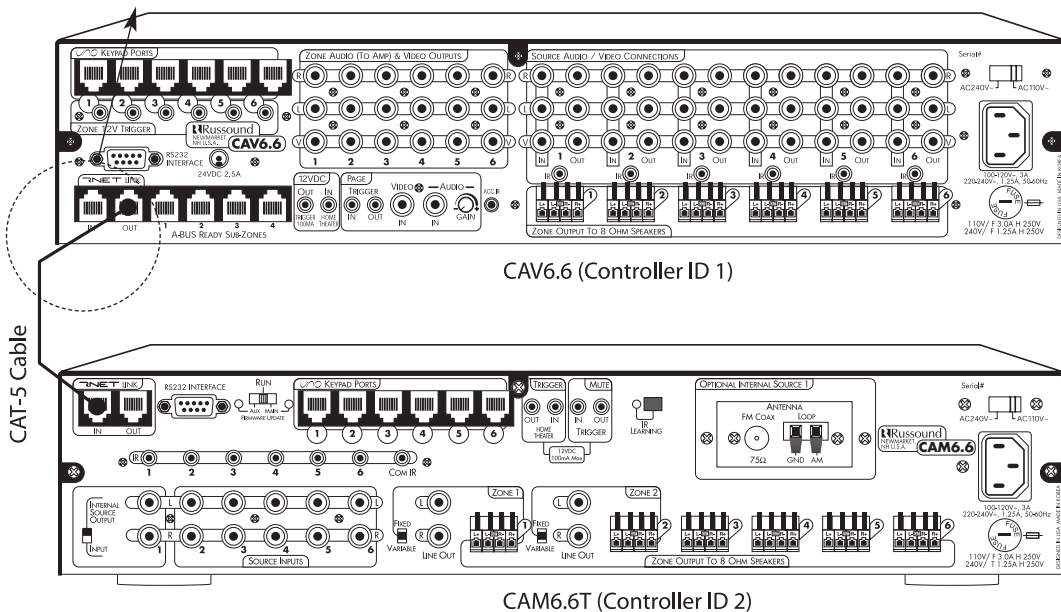
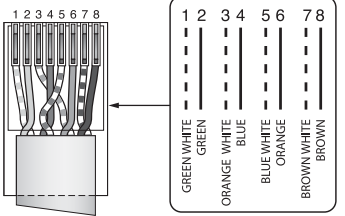

INSTALLER

MAKING CONNECTIONS

RNET Link In and Link Out - RNET-enabled Components

The RNET Link In and Link Out is also used to connect the CAV6.6 to other Russound RNET-enabled products. The connection is made using a CAT-5 patch cable from the Link Out of the controller and into the Link In of the RNET-enabled component. Another CAT-5 patch cable can be used to link out of that component and link into another RNET-enabled component in the system.

RNET-enabled components fully integrate with CAV6.6 and CAM6.6 multi-zone systems. They communicate through the RNET Link In and Link Out connection. These components can be controlled via the UNO keypad or the SRC2 remote control, and display source information on the keypads. The CAT-5 patch cable should not exceed 18 inches in length.

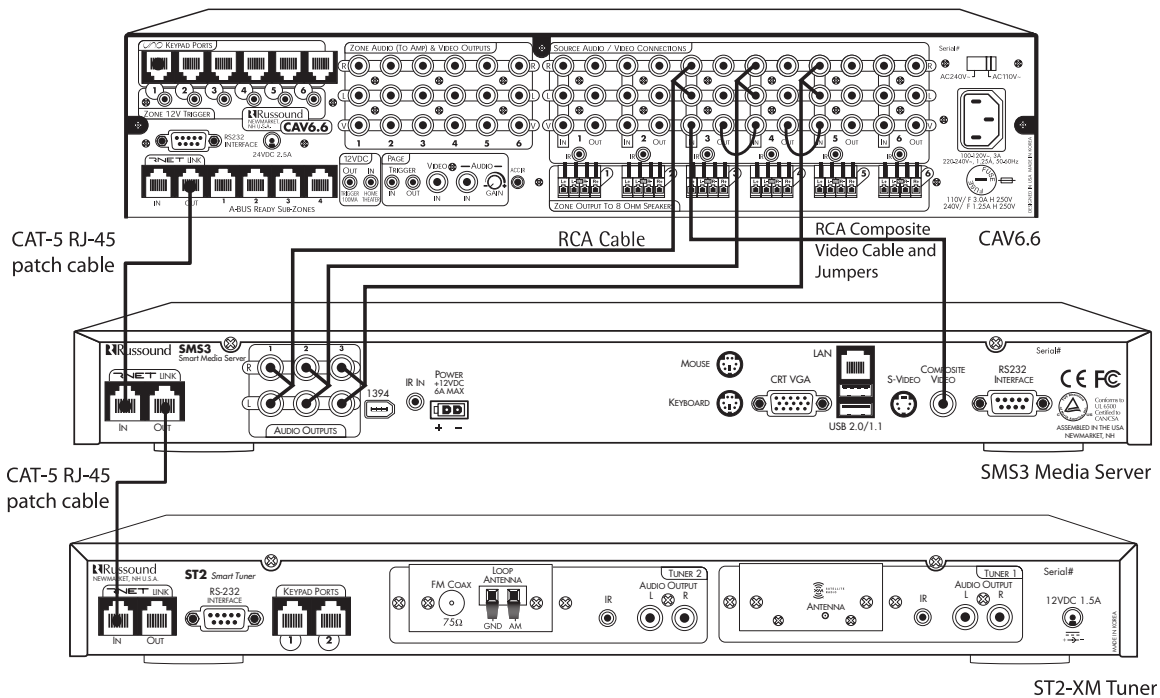

INSTALLER MAKING CONNECTIONS

RS-232 Interface

The CAV6.6 supports RS-232 communication with various third-party automation systems through the RS-232 ports. These ports are also used for firmware updates, and for controller programming through the PC Power Tool software program.

The two RS-232 com ports are located on the front and the back of the CAV6.6 and use a DB-9 cable connection. Before performing

updates or programming, select a front or rear RS-232 port and set the Front/Rear RS-232 switch on the front of the controller as well. The switch is located next to the DB-9 port.

For RS-232 protocol, available firmware updates and the RNET Backup Utility, see the Document Center at www.russound.com. Look for the Technical Documents under RNET Systems.

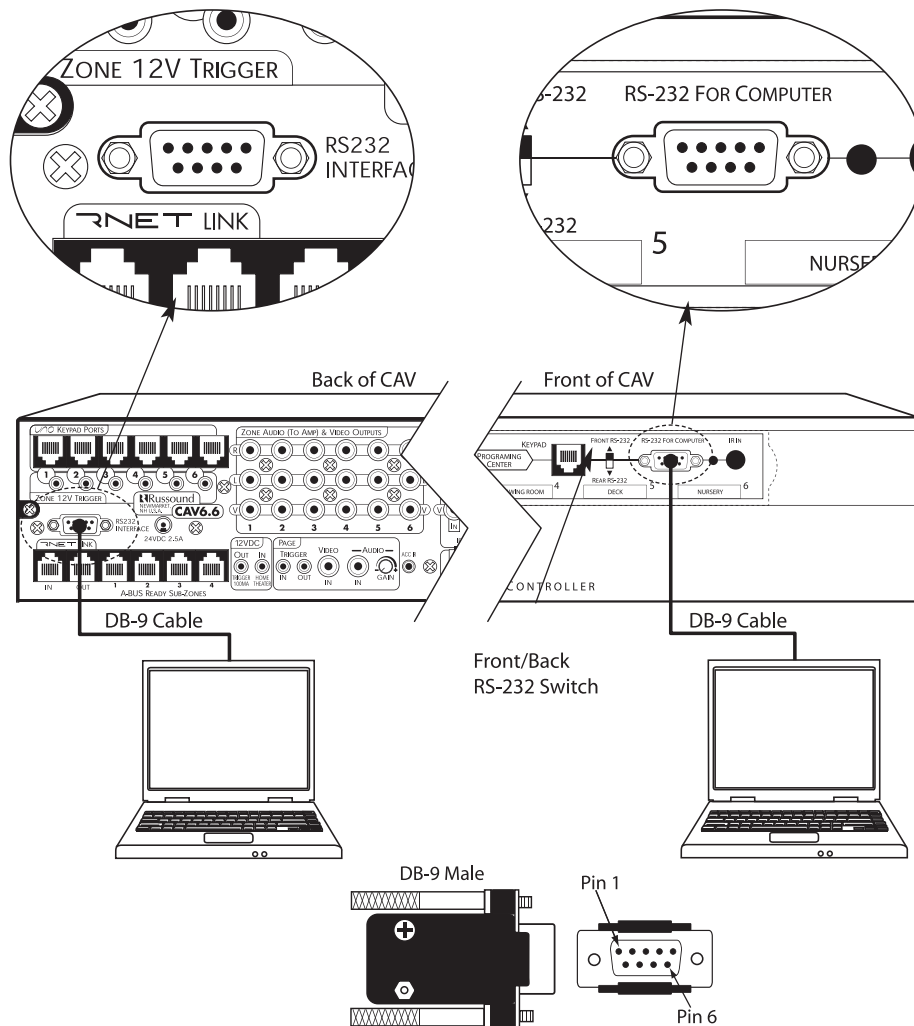

INSTALLER

MAKING CONNECTIONS

Programming Center Keypad Port Connection

The CAV6.6 can be programmed via keypad connection using CAT-5 and the T568A RJ-45 wire configuration. An UNO-S2 Keypad can be attached to the controller at the Programming Center Keypad Port Connection.

ally for learning IR commands directly into the IR receiver on the controller's front panel. (see **Learn IR flow chart on page 70**).

The CAV6.6 can also be programmed from any UNO-S2 keypad connected to its keypad ports.

The Programming Center Keypad Port is designed for use in local programming, specifi-

RJ-45 Connection Details

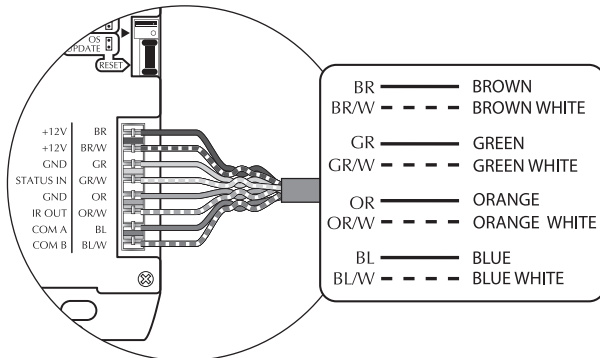
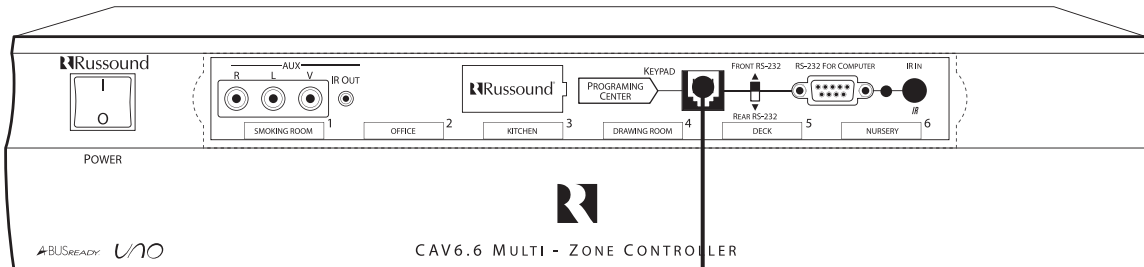
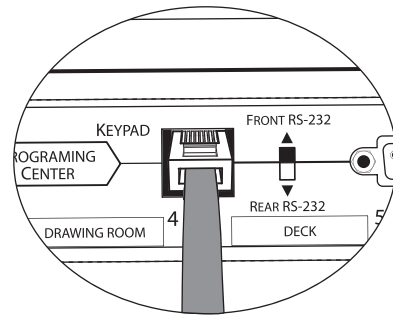
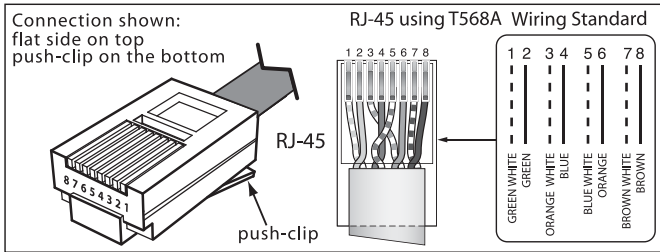

CAT-5 to UNO - Connection

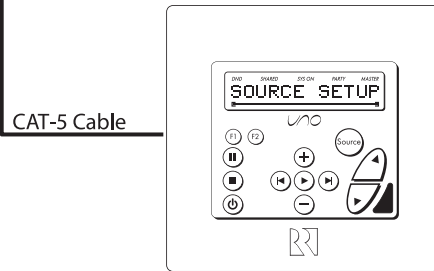

INSTALLER INITIAL INSTALL TEST

Before proceeding to the system programming section, it's important to conduct an initial test to determine that the hardware components are working properly.

1. Connect the speaker wires from Zone #1 to the CAV6.6 Zone #1 speaker output connectors.
2. Connect an UNO keypad to Keypad Port #1 on the rear of the CAV6.6.
3. Connect a source to the Source #1 Input on the CAV6.6 using RCA A/V patch cables.
4. Plug a supplied 845.1 IR emitter into the Source #1 IR Output Jack and adhere the emitter end to the source equipment's IR window.
5. Plug in the main power cords for the CAV6.6 and the source.
6. Turn on the main power switch on the CAV6.6 and the source.
7. Manually command the source to provide audio or use the source remote control.
8. Press the power button on the UNO keypad and select Source #1.
9. To verify emitter placement, take source equipment's factory remote control and aim at a keypad (not in same room as source equipment). Source equipment should respond to IR command.

Congratulations – you should now hear the source through the speakers in Zone #1. Now that you have confirmed the hardware operation, you can proceed to System Programming to set up keypad source control.

If there is no sound, follow these diagnostic steps:

1. Check the source to see that it is operating properly.
2. Check the RCA A/V cable connections from the source to the Source #1 Input on the CAV6.6.
3. Check the speaker connections and verify that they are correct and are connected to the Zone #1 speaker outputs.
4. Check to see that the keypad is connected to the Zone #1 Keypad Port and verify the CAT-5 is properly terminated at both ends.

If none of these steps produce successful results, call Russound Tech Support for further assistance.

INSTALLER PROGRAMMING

System Programming Overview

This manual includes items that are designed to assist in the programming process.

Sample Configurations (Pages 80-91)

A series of sample configurations are provided to showcase a variety of system designs and component options.

Forms (pages 46-48)

Three blank reproducible forms are included as planning tools when determining sources, settings and zone preferences. The Source and Zone Information forms and the Macro Editor form should be completed before programming and referred to during the installation menu process. This speeds up programming time and reduces missed or incorrect entries. These forms also serve as system reference documents if future troubleshooting is needed.

IR Device Codes (Pages 74-77)

This list of command type IR device codes reflects the built-in IR codes in the CAV6.6 library. During programming, these codes will be entered for each source at the "Device Code" prompt. If a code is not listed for a source, the Learn IR procedure is available to learn in and centrally store IR codes.

Key Functions (Pages 92-113)

This list of key functions identifies what IR codes are supported for each command type (source) by the built-in library. "Learned Only" indicates that this function is not supported and must be learned into the CAV6.6. This list of key functions reflects the different available key functions associated with what you see on the LCD panel when performing the Key Configuration procedure in the Installation Menu. The list of functions corresponds with the command types above (e.g., Tuner, CD player, etc.).

Source Names (Pages 78-79)

A list of assignable Source Names is provided for advance selection and source form completion before programming.

Flow Charts (Pages 62-72)

Installation Menu flow charts provide a graphical representation of the programming process.

Installation Menu (Pages 49-61)

The Installation Menu provides the step-by-step complete programming procedure for the keypad and the controller.

Although you can begin programming at any point within the Installation Menu, the following sequence is recommended for initial installations, as it progresses from the most basic requirements to the more advanced features.

1. Controller Setup (CTRLR SETUP) (Page 57)

This procedure sets the controller ID number within the system. This number must be manually set when multiple CAV6.6's are linked through RNET within one system. This procedure is not necessary for systems with only one CAV6.6.

(continued)

System Programming Overview (cont'd)

2. Number of Sources (# of Sources/SOURCE SETUP) (Page 56)

This procedure sets the number of sources used in the system. This prevents the user from selecting a source input that is not used.

3. Basic Setup (SOURCE SETUP) (Page 50)

This procedure is mandatory to set up each source for keypad source control and is the cornerstone of the programming process.

4. Learn IR (Page 59)

This procedure is used when the source-specific IR code is not found in the built-in IR code library. This allows IR commands to be learned into the system and centrally stored.

5. Macro Editor (Page 60)

This procedure compiles multiple IR codes to be initiated by a single button press. One macro can have up to 10 commands, including other macros, and up to 132 macros can be entered.

6. Source Volume Trim (SOURCE SETUP) (Page 53)

This procedure matches audio output signals for all sources for seamless switching.

7. Numeric IR (SOURCE SETUP) (Page 53)

This procedure sets up control of a source that supports direct numeric commands.

8. Key Configuration (SOURCE SETUP) (Page 51)

This procedure customizes individual key functions on a per-zone basis for source control.

9. Power Management (Page 57)

This function incorporates IR macro commands to automatically control the power state of the sources when the system is in use or when a home theater is sharing sources. This advanced feature uses audio signal monitoring to confirm source power, which provides the user with worry-free operation.

10. Zone Volume Trim (ZONE SETUP) (Page 56)

This procedure limits the maximum volume allowed in a zone, regardless of keypad volume adjustment.

11. System On Enable (SYSON ENABLE/ZONE SETUP) (Page 56)

This feature allows a zone to join or opt out of an "all on" command.

12. Party Enable (ZONE SETUP) (Page 56)

This feature allows a zone to join or opt out of Party Mode participation.

13. Master Enable (ZONE SETUP) (Page 56)

This feature allows a zone the option of becoming a Master keypad in Party Mode.

14. Page Enable (ZONE SETUP) (Page 57)

This feature allows a zone to hear or to block paging.

15. Page Volume (ZONE SETUP) (Page 57)

This feature allows adjustment of the paging volume in a zone.

Source Information Form

Source Information Form

	Source 1	Source 2	Source 3	Source 4	Source 5	Source 6
Source Name						
Manufacturer						
Model #						
IR Command Type *						
IR Device Code (learned or 4-digit)						
Numeric IR (Y or N)						
Highest Number						
Auto Play (Y or N)						
Source Volume Trim (dB) -16dB<->0dB						
Source Select Command						
Power Mgmt Power On Command						
Power Mgmt Signal Sense Delay (No, 5-60 sec)						
Power Off Command						

*IR Command Type, e.g., TV, Cable, SAT/DSS, VCR, LD, DVD, Tuner, CD, etc.

Zone Information Form

Zone Information Form

Zone Number	Zone Name	Zone Volume Trim -16dB <-> 0dB	System On Enable	Party Mode Enable	Master Keypad Enable	Page Enable	Page Volume 0 min - 100 max
1			Y N	Y N	Y N	Y N	
2			Y N	Y N	Y N	Y N	
3			Y N	Y N	Y N	Y N	
4			Y N	Y N	Y N	Y N	
5			Y N	Y N	Y N	Y N	
6			Y N	Y N	Y N	Y N	

(Default setting is bolded)

Macro Editor Form

Macro Editor Form

Macro ID Number	Macro Name	Command 1	Command 2	Command 3	Command 4	Command 5	Command 6	Command 7	Command 8	Command 9	Command 10

Macro ID Number	Macro Name	Command 1	Command 2	Command 3	Command 4	Command 5	Command 6	Command 7	Command 8	Command 9	Command 10













INSTALLER

INSTALLATION MENU OVERVIEW

There are three item types in the installation menu:

- Menu** – “Folder” that holds procedures and/or feature options.
- Procedure** – A series of steps to perform a guided operation, such as configuring a button.
- Feature** – The actual settings that will change the system configuration.

The following **UNO-S1** and **UNO-S2** buttons are used to navigate and make selections while using the installation menus. The UNO-TS2 does not support access to the Installation Menu.

UNO-S1	UNO-S2	Button Function
		Setup button (located under cover plate on the keypad's right side) - Press and release while in normal operating mode to enter the Installation Menu. Press to back out of any procedure and return to beginning of Installation Menu, then to normal operating mode.
		Adjust feature setting (increment)
		Adjust feature setting (decrement)
		Go to next menu / procedure / feature. Not available while performing a procedure
		Go to previous menu / procedure / feature. Not available while performing a procedure
		Enter menu / begin procedure / show current feature setting. While performing a procedure, it is also used to advance to the next sequential feature setting once the current feature has been viewed or adjusted.







UNO-S1 Keypad Five-character Display

The UNO-S1 keypad abbreviates information as necessary to appear in its five-character display. In the following menu procedures, the UNO-S1 five-character abbreviation is shown in parentheses underneath the 12-character version.

INSTALLER

INSTALLATION MENU







The following items make up the Installation Menu:

SOURCE SETUP (SrcSu)  ZONE SETUP (ZonSu)  CTRLR SETUP (CtlSu) 
POWER MGT (PwMgt)  LEARN IR (LrnIR)  MACRO EDITOR (MacEd) 
SYSTEM INFO (SInfo) 

SOURCE SETUP (SrcSu)

Source Setup allows the system's sources to be configured.

The following items can be found in the SOURCE SETUP menu:

BASIC SETUP (BasSu)  KEY CONFIG (KeyCf)  SOURCE NAMES (SrcNm) 
SRC VOL TRIM (SrcVT)  NUMERIC IR (NumIR)  SRC SEL CMD (SrcSC) 
OF SOURCES (#Srcs) 

BASIC SETUP (BasSu)

NOTE: The BASIC SETUP procedure should be performed for each source before proceeding to other source setting changes.

This procedure uses built-in source "templates" to quickly and easily configure the source settings needed for basic operation of the source component. Before performing BASIC SETUP, connect the source components to the CAV 6.6 as outlined in the Source Connections section. Also be sure that all sources are powered on. **See Basic Setup - Flow Chart on page 62**

1. **SOURCE NUM** – Select the source to be configured.
(Src #)
2. **SOURCE NAME** – Select the name for the source (e.g., DVD, Aux 2, Jazz, etc.).
(Name)
3. **COMMAND TYPE** – Select the type of command template (e.g., CD, TV, etc.). Selecting the command type template will tell the CAV 6.6 how to configure the key's command and text for the source component.
(CmdTp)
 - a. **Selected: Learned IR** Choose Learned IR if the pre-programmed IR code library does not support the source component.
(LrnIR)
 - i. **LEARNED SRC** – Select the learned source bank to be assigned to the source component. (See Learning IR procedure for instructions on how to learn IR codes.)
(LnSrc)

INSTALLER INSTALLATION MENU

Basic Setup (cont'd.)

- ii. **TEMPLATE TYP** –
(TType) Select the template type to define what type of source component is being used. (This will tell the CAV 6.6 how to configure the key commands and text for the source component if it is a learned source.) Procedure advances to USE NUM IR? (step 7).
- b. **Selected: Unassigned**
(Unasg) The template for the selected source is cleared. (All key assignments and other source settings will be erased.) Procedure advances to SAVE CHANGES (step 10)
- c. **All Other Selections:** Procedure advances to DEVICE CODE (step 4)
- 4. **DEVICE CODE** –
(DevCd) Enter source component code number listed in this manual's Reference section.
- 5. **TEST IR?** –
(TstIR) If "Yes" is selected, the CAV 6.6 sends a power command to the source component. If "No" is selected, the procedure advances to USE NUM IR? (step 7)
- 6. **SUCCESS?** –
(OK?) If the power to the source component was turned off, select "Yes" otherwise select "No." By selecting "No" the Procedure returns to DEVICE CODE (step 4) to allow selection of another code number from the provided list.
- 7. **USE NUM IR?** –
(NumIR) Indicates the source component has numeric scrolling, such as multi-disc CD player (See NUMERIC IR Setup Procedure for advanced settings or more information). "No" advances menu to AUTO PLAY (step 9).
- 8. **HIGHEST NUM** –
(High#) Enter the highest possible number; for example, a 100-disc CD player would have a max number of 100.
- 9. **AUTO PLAY?** –
(AtoPI) "Yes" tells the CAV 6.6 to issue a PLAY command whenever the source is selected for listening. This option is skipped if the source type (COMMAND TYPE) chosen does not have a PLAY command associated with it.
- 10. **SAVE CHANGES?** –
(Save?) Select "yes" to save changes. Procedure returns to SOURCE NUM to allow configuration of another source.

KEY CONFIG (KeyCf)

Key Configuration defines zone-specific key functions for each source. **See Key Config. - Flow Chart on page 63**

- 1. **ZONE NUM** –
(Zone#) Select the zone the key will be configured for. Changes are made for that zone only; default setting is "All Zones."

INSTALLER INSTALLATION MENU

Key Config (cont'd.)

2. **SOURCE NUM** –
(Src #) Select the source the key will be configured for.
3. **SELECT A KEY** –
(SelKy) Using ⊕ or ⊖, select the keypad key to be configured.
4. **KEY TYPE** –
(KeyTp) Either “Key Press,” “Key Hold” or “Both” will activate the command.
5. **KEY NAME** –
(KeyNm) Name that appears on the keypad display when the command is activated.
6. **COMMAND TYPE** –
(CmdTp) Select the type of source command (e.g., CD, TV, etc.).
 - a. **Selected: Learned IR** –
(LrnIR) Choose Learned IR if the pre-programmed IR code library does not support the source component.
 - i. **LEARNED SRC** –
(LnSrc) Select the learned source bank to be assigned to the source component. Procedure advances to KEY FUNCTION (step 8)
 - b. **Selected: Unassigned**
(Unasg) The key configuration is cleared. Procedure advances to SAVE CHANGES (step 9)
 - c. **Selected: Default**
(Deflt) Default selects the same device type and device code previously setup in BASIC SETUP. Procedure advances to KEY FUNCTION (step 8)
 - d. **Selected: Macro:**
 - i. **MACRO** -
(Macro) **(To build macros, see Macro Editor page 60)**
Macro loads a series of commands which are processed when activated.
 - ii. **MACRO ID** –
(MacID) Enter the macro ID number. Menu advances to SAVE CHANGES (step 9)
 - e. **All Other Selections:**
Procedure advances to DEVICE CODE (step 7)
7. **DEVICE CODE** –
(DevCd) Enter source component code number listed in this manual's Reference section.
8. **KEY FUNCTION** –
(KeyFn) Select a function for the button.
9. **SAVE CHANGES?** –
(Save?) Select “yes” to save changes. Procedure advances to ZONE NUM (step 1)

INSTALLER INSTALLATION MENU

SOURCE NAMES (SrcNm)

This procedure allows the installer to customize the source names for the sources attached to the CAV6.6. **See Source Setup Menu on Page 50 and Source Names/Vol Trim - Flow Chart on page 64**

- 1. SOURCE NUM –**
(Src #) Select the source number this name will be assigned to.
- 2. SOURCE NAME –**
(Name) Select the name. SOURCE NUM will reappear on the LCD panel; repeat the instructions for each source to be labeled.

SRC VOL TRIM (SrcVT)

This procedure allows the installer to adjust the output level of an individual source. The output volume is adjustable by 16 dB. At 0 dB (the default setting), the volume is at max output; at -16 dB the volume is at the lowest setting possible for that source only. **See Source Setup Menu on Page 50 and Source Names/Vol Trim - Flow Chart on page 64**

- 1. SOURCE NUM –**
(Src #) Select the source number this level will be set for.
- 2. TRIM LEVEL –**
(Trim) 0 dB is max output volume, -16 dB is lowest setting.

NUMERIC IR (NumIR)

Numeric IR allows the installer to program source specific number functions (Channel 12, Disk 89, etc.). **See Source Setup Menu on Page 50 and Numeric IR - Flow Chart on page 65**

- 1. SOURCE NUM –**
(Src #) Select the source number this function will be configured for.
- 2. USE NUM IR? –**
(NumIR) Tells the system whether the source component has numeric scrolling, such as 100-disc CD player. A selection of "no" disables Numeric IR and advances to SAVE CHANGES
- 3. HIGHEST NUM –**
(High#) Enter the highest possible number; for example, the 100-disc CD player would have a max number of 100.
- 4. NUMERIC TEXT –**
(NmTxt) Select Numeric descriptive text.
- 5. PREFIX CMD –**
(Prefx) Tells the system whether a command will be issued prior to the selection of the numerical value (e.g., Disc 1,2). If "no," procedure advances to SUFFIX CMD (step 9)
- 6. COMMAND TYPE –**
(CmdTp) Select the type of command (e.g., CD, TV, etc.).

R INSTALLER

INSTALLATION MENU

Numeric IR (cont'd)

- | | |
|--|---|
| <ul style="list-style-type: none"> a. Selected: Learned IR
(LrnIR) | Choose Learned IR if the pre-programmed IR code library does not support the source component. |
| <ul style="list-style-type: none"> i. LEARNED SRC –
(LnSrc) | Select the learned source bank to be assigned to the source component. Procedure advances to KEY FUNCTION (step 8) |
| <ul style="list-style-type: none"> b. Selected: Unassigned
(Unasg) | The numeric IR Prefix command is cleared. Procedure advances to SUFFIX CMD (step 9) |
| <ul style="list-style-type: none"> c. Selected: Default
(Deflt) | Default selects the same device type and device code previously setup in BASIC SETUP. Procedure advances to KEY FUNCTION (step 8) |
| <ul style="list-style-type: none"> d. Selected: Macro: <ul style="list-style-type: none"> i. MACRO -
(Macro) ii. MACRO ID –
(MacID) | <p>(To build macros, see Macro Editor page 60)
Macro loads a series of commands which are processed when activated.</p> <p>Enter the macro ID number. Menu advances to SUFFIX CMD (step 9)</p> |
| <ul style="list-style-type: none"> e. All Other Selections: | Procedure advances to DEVICE CODE (step 7) |
| <ul style="list-style-type: none"> 7. DEVICE CODE –
(DevCd) | Source component code for IR control. |
| <ul style="list-style-type: none"> 8. KEY FUNCTION –
(KeyFn) | Select a function (Disc, etc.). |
| <ul style="list-style-type: none"> 9. SUFFIX CMD –
(Sufix) | Tells the system whether a command will be issued after the selection of the numerical value (e.g., 1, 2 <i>Enter</i>). If “no,” procedure advances to SAVE CHANGES (step 13) |
| <ul style="list-style-type: none"> 10. COMMAND TYPE –
(CmdTp) | Select the type of source command (e.g., CD, TV, etc.). |
| <ul style="list-style-type: none"> a. Selected: Learned IR
(LrnIR) | Choose Learned IR if the pre-programmed IR code library does not support the source component. |
| <ul style="list-style-type: none"> i. LEARNED SRC –
(LnSrc) | Select the learned source bank to be assigned to the source component. Procedure advances to KEY FUNCTION (step 12) |
| <ul style="list-style-type: none"> b. Selected: Unassigned
(Unasg) | The numeric IR Suffix command is cleared. Procedure advances to SOURCE NUM (step 1) |
| <ul style="list-style-type: none"> c. Selected: Default
(Deflt) | Default selects the same device type and device code previously setup in BASIC SETUP. Procedure advances to KEY FUNCTION (step 12) |
| <ul style="list-style-type: none"> d. Selected: Macro: | (To build macros, see Macro Editor page 60) |

INSTALLER INSTALLATION MENU

Numeric IR (cont'd)

- i. **MACRO** - (Macro) Macro loads a series of commands which are processed when activated.
- ii. **MACRO ID** - (MacID) Enter the macro ID number. Menu advances to SAVE CHANGES (step 13)
- e. **All Other Selections:** Procedure advances to DEVICE CODE (step 11)
- 11. **DEVICE CODE** - (DevCd) Source component code for IR control.
- 12. **KEY FUNCTION** - (KeyFn) Select a function (Enter, Play, etc.).
- 13. **SAVE CHANGES?** - (Save?) Select "yes" to save the changes.

SRC SEL CMD (SrcSC)

This procedure permits a command to be sent to the source component when the source component is initially selected. **See Source Setup Menu on Page 50 and Source Select Command & # Of Sources - Flow Chart on page 66**

- 1. **SOURCE NUM** - (Src #) Select the source number this command will be configured for.
- 2. **COMMAND TYPE** - (CmdTp) Select the type of source command (e.g., CD, TV, etc.).
 - a. **Selected: Learned IR** (LrnIR) Choose Learned IR if the pre-programmed IR code library does not support the source component.
 - i. **LEARNED SRC** - (LnSrc) Select the learned source bank to be assigned to the source component. Procedure advances to KEY FUNCTION (step 4)
 - b. **Selected: Unassigned** (Unasg) The source select command is cleared. Procedure advances to SAVE CHANGES (step 5)
 - c. **Selected: Default** (Deflt) Default selects the same device type and device code previously setup in BASIC SETUP. Procedure advances to KEY FUNCTION (step 4)
 - d. **Selected: Macro:**
 - (To build macros, see Macro Editor page 60)
 - i. **MACRO** - (Macro) Macro loads a series of commands which are processed when activated.
 - ii. **MACRO ID** - (MacID) Enter the macro ID number. Menu advances to SAVE CHANGES (step 5)

INSTALLER INSTALLATION MENU

Source Select Command (cont'd)

- e. All Other Selections: Procedure advances to DEVICE CODE (step 3)
- 3. DEVICE CODE – Source component code for IR control.
(DevCd)
- 4. KEY FUNCTION – Select a function (Play, Enter, etc.).
(KeyFn)
- 5. SAVE CHANGES? – Select “yes” to save the changes.
(Save?)

OF SOURCES (#Srcs)

At this field it is necessary to enter the number of sources used in the CAV6.6 system (1 to 6). This limits the sources displayed on the keypad in the normal running mode when the source button is pressed, but also limits source selections in the configuration menus. **See Source Setup Menu on Page 50 and Source Select Command & # Of Sources - Flow Chart on page 66**

ZONE SETUP (ZonSu)

NOTE: This procedure should be performed using the keypad installed in the zone to be configured. **See Installation Menu on Page 50 and Zone Setup - Flow Chart on page 67**

Zone Setup allows the installer to adjust properties of the UNO Keypad controlled CAV6.6 zone. This series of menus allows the system's zones to be configured for these properties:

ZON VOL TRIM (ZonVT) SYSON ENABLE (SysOn) PARTY ENABLE (PtyEn) MASTER ENABL (MstEn) PAGE ENABLE (PagEn) PAGE VOLUME (PagVI)

- 1. ZON VOL TRIM - This feature allows the installer to adjust the output volume to each zone. -16 dB (lowest) to 0 dB (max)(default).
(ZonVT)
- 2. SYSON ENABLE - This feature is either disabled or enabled. If disabled (default), an All On command activated from another zone will not turn on the disabled zone. If enabled, an All On command activated from another zone will turn on the enabled zone.
(SysOn)
- 3. PARTY ENABLE - This feature is either disabled or enabled. If disabled, Party Mode activation from another zone will not affect the disabled zone. If enabled (default), the zone will participate with Party Mode.
(PtyEn)
- 4. MASTER ENABLE - This feature is either disabled or enabled. If disabled, the zone cannot host a master keypad during Party Mode. If enabled (default), the zone has the option of hosting the Master keypad.
(MstEn)

INSTALLER INSTALLATION MENU

Zone Setup (cont'd)

- 5. **PAGE ENABLE** - (PagEn) This feature is either disabled or enabled. It allows the option of receiving or blocking a page in a zone. If disabled, the page will not be sent to the zone. If enabled (default), the page will be sent to the zone.
- 6. **PAGE VOLUME** - (PagVl) This feature allows the installer to adjust the Page Volume for the zone, from 0 (min) to 100 (max).

CTRLR SETUP (Ctlld)

Controller Setup is the basic configuration of the controller. This setup menu selects the options for Controller ID and Factory Initialization. **See Installation Menu on Page 50 and Controller Setup - Flow Chart on page 68**

- 1. **CONTROLLER ID** - (Ctlld) This defines the Controller ID for this system. The default is 1 but when multiple controllers are used, each additional controller ID must be sequential and unique and be set before being connected to the system. Note that the system must be restarted before the controller will assume the new ID.
- 2. **FACTORY INIT** - (Flnit) **WARNING: This procedure returns the controller to its original settings - use with discretion.**
Factory Initialization allows the installer to erase all programmed settings and returns the settings to the factory default settings. All settings including source equipment IR commands will need to be reentered. An "Are you sure?" prompt and a "no" response allows the installer to cancel the reset; a "yes" at the prompt will load factory/default settings.

POWER MGT (PwMgt)

The CAV6.6 is capable of managing the power state of the connected source equipment. The power management is configured on a source-by-source basis.

All sources that have power management enabled are initialized by a "POWER ON" command or macro which must cause the source to produce an audio signal. Power management is initialized when the first keypad is turned on or when the home theater trigger input has 12VDC present. The 12VDC trigger output is turned on when the first zone is turned on.

All sources that have power management enabled are turned off by the "POWER OFF" command after all zones have been turned off, with a timeout of five minutes. The 12VDC trigger output is turned off

INSTALLER INSTALLATION MENU

Power Management (cont'd)

- 7. POWER OFF CMD –** (OfCmd) Tells the controller to turn off the selected source equipment (by SOURCE NUMBER) when the last of the UNO System Keypads is turned off. If “no,” procedure advances to SAVE CHANGES (step 11)
- 8. COMMAND TYPE –** (CmdTp) Select the type of source command (e.g., CD, TV, etc.).
- a. Selected: Learned IR** (LrnIR) Choose Learned IR if the pre-programmed IR code library does not support the source component.
 - i. LEARNED SRC –** (LnSrc) Select the learned source bank to be assigned to the source component. Procedure advances to KEY FUNCTION (step 10)
 - b. Selected: Unassigned** (Unasg) The Power Off command is cleared. Procedure advances to SAVE CHANGES (step 11)
 - c. Selected: Default** (Deflt) Default selects the same device type and device code previously setup in BASIC SETUP. Procedure advances to KEY FUNCTION (step 10)
 - d. Selected: Macro:**
 - i. MACRO –** (Macro) **(To build macros, see Macro Editor page 60)** Macro loads a series of commands which are processed when activated.
 - ii. MACRO ID –** (MacID) Enter the macro ID number. Menu advances to SAVE CHANGES (step 11)
 - e. All Other Selections:** Procedure advances to DEVICE CODE (step 9)
- 9. DEVICE CODE –** (DevCd) Source component code for IR control.
- 10. KEY FUNCTION –** (KyFn) Select Keypad function.
- 11. SAVE CHANGES? –** (Save?) Select “yes” to save the changes.

LEARN IR (LrnIR)

This procedure allows IR commands to be learned into the system and be centrally stored in the main controller to let the system access the same IR codes that operate the source equipment.

NOTE: IR codes must be learned in pointing the source's remote control at the CAV6.6's front panel IR receiver. Use a keypad connected to the CAV6.6's front panel programming port for convenience in navigating the Learn IR procedure menu. **See Installation Menu on Page 50 and Learn IR - Flow Chart on page 70**

INSTALLER INSTALLATION MENU

Learn IR (cont'd)

1. **LEARNED SRC** –
(LnSrc) Select the source whose commands will be learned into the controller.
2. **KEY FUNCTION** –
(KeyFn) Select the function to be learned or deleted.
3. **LEARN/DELETE** –
(Ln/Dl) Select Learn IR Now or Delete IR. If Learn IR Now, a “USE REMOTE” prompt appears. Point the learning remote at the controller’s IR window. If Delete IR, procedure returns to LEARNED SRC (step 1)
4. **TEST IR?** –
(TstIR) If “yes,” sends the learned command to the source component to test the IR. If the component responds, the IR test was a success. If the component does not respond the Code was not learned properly. If “no,” menu goes back to LEARNED SRC (step 1)
5. **SUCCESS?** -
(OK?) Asks if the IR test was a success
IF YES - If the test was a success, specify “yes” and proceed to KEY FUNCTION (step 2)

IF NO - If the test was a failure, specify “no” and LEARN/DELETE (step 3) reappears on the display allowing another code to be learned in.

MACRO EDITOR (MacEd)

This procedure is used to create a sequence of commands that are launched with one key touch or other event. Up to 132 macros can be created for the system, and each macro can contain up to 10 commands including other macros. **See Installation Menu on Page 50 and Macro Editor - Flow Chart on page 71**

1. **MACRO ID** –
(MacID) Number of Macro up to 132 including any previously named macros.
2. **MACRO NAME** –
(MacNm) Name of Macro (optional).
3. **COMMAND NUM** –
(Cmd#) Number of Command up to 10.
4. **COMMAND TYPE** –
(CmdTp) Select the type of source command (e.g., CD, TV, etc.).
 - a. **Selected: Learned IR**
(LrnIR) Choose Learned IR if the pre-programmed IR code library does not support the source component.





INSTALLER INSTALLATION MENU

Macro Editor (cont'd)

- i. **LEARNED SRC** – (LnSrc) Select the learned source bank to be assigned to the source component. Procedure advances to KEY FUNCTION (step 6)
- b. **Selected: Unassigned** (Unasg) Selected command and subsequent commands are cleared. Procedure advances to COMMAND NUM (step 3)
- c. **Selected: Default** (Deflt) Default selects the same device type and device code previously setup in BASIC SETUP. Procedure advances to KEY FUNCTION (step 6)
- d. **Selected: Macro:**
 - i. **MACRO** - (Macro) A macro can “call” another macro if a sequence of more than 10 commands is needed.
 - ii. **MACRO ID** – (MacID) Enter the macro ID number. Menu advances to COMMAND NUM (step 3)
- e. **Selected: Delay** (Delay) Enter a 1- to 60-second delay time to postpone delivery of the next command in the macro. Procedure advances to COMMAND NUM (step 3)
- f. **All Other Selections:** Procedure advances to DEVICE CODE (step 6)
- 5. **DEVICE CODE** – (DevCd) Source component code for IR control.
- 6. **KEY FUNCTION** – (KeyFn) Select a function (Play, etc.).

SYSTEM INFO (SInfo)

System Info allows the installer to view the controller's manufacturing build properties.
See *Installation Menu on Page 50 and System Info - Flow Chart on page 72*

#CONTROLLERS (#Ctls)  BUILD TIME (BTime)  BUILD DATE (Bdate)  VERSION (Ver) 

- 1. **#CONTROLLERS** - (#Ctls) Displays the number of CAV6.6 controllers in the system.
- 2. **BUILD TIME** - (BTime) Displays the Software Build Time of the controller.
- 3. **BUILD DATE** - (BDate) Displays the Software Build Date of the controller.
- 4. **VERSION** - (Ver) Displays the software version of the CAV6.6.

INSTALLER SETUP MENU FLOW CHARTS

Source Setup: Key Configuration

NOTE: Diagram shows UNO-S2 keypad buttons used in the programming procedure.
Corresponding UNO-S1 keypad buttons:

UNO-S1: 

UNO-S2: 

Installation Menu

Source Setup: Key Configuration

CAUTION: Changes within the Installation Menu can affect proper operation and should be performed by qualified personnel

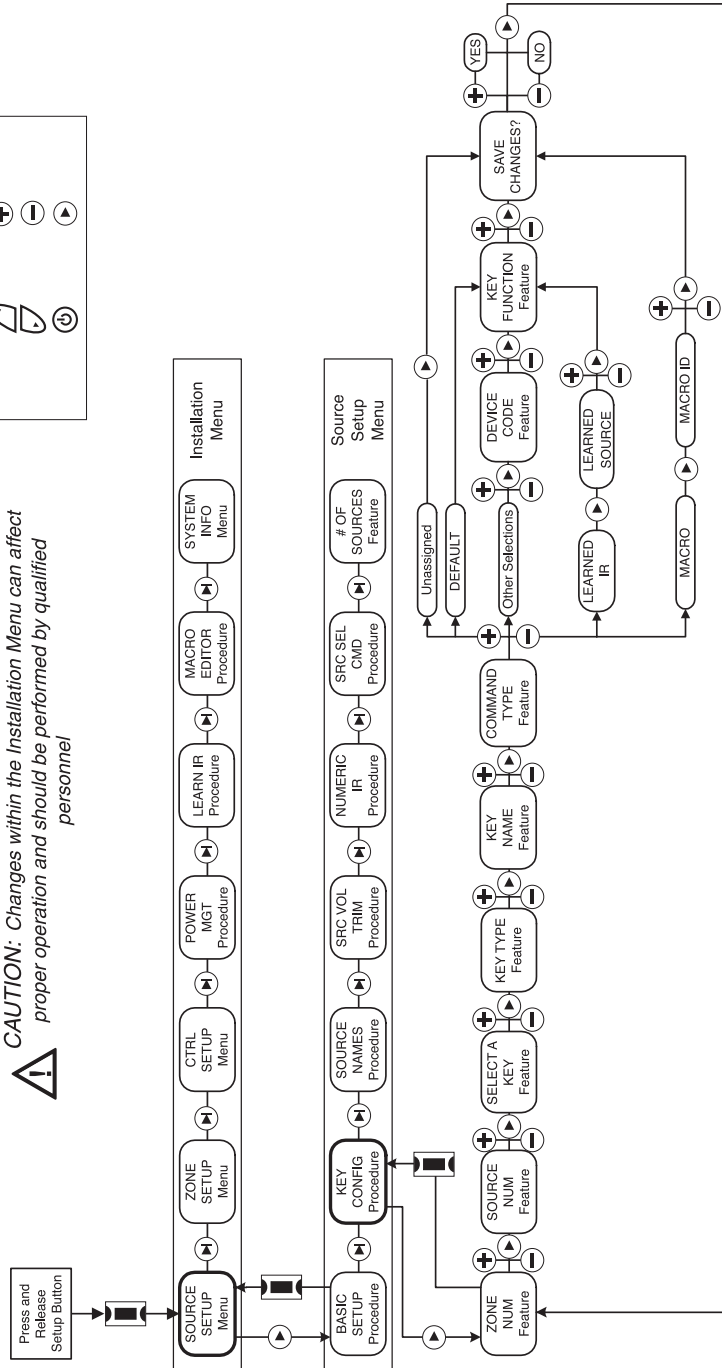







INSTALLER

SETUP MENU FLOW CHARTS

Source Setup: Source Names/Volume Trim

NOTE: Diagram shows UNO-S2 keypad buttons used in the programming procedure.
 Corresponding UNO-S1 keypad buttons:

UNO-S1:   

UNO-S2:   

Installation Menu

Source Setup: Source Names/Vol Trim

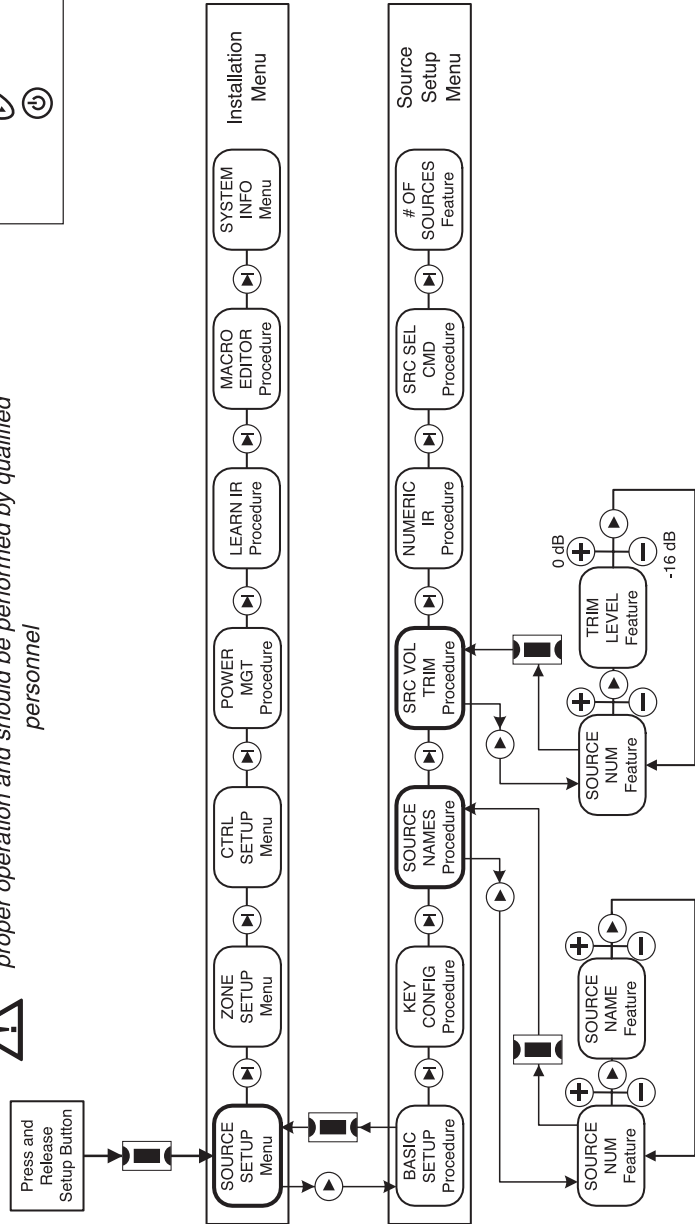

CAUTION: Changes within the Installation Menu can affect proper operation and should be performed by qualified personnel



INSTALLER SETUP MENU FLOW CHARTS

Source Setup: Numeric IR

NOTE: Diagram shows UNO-S2 keypad buttons used in the programming procedure.
Corresponding UNO-S1 keypad buttons:

UNO-S1:  UNO-S2: 

Installation Menu

Source Setup: Numeric IR

CAUTION: Changes within the Installation Menu can affect proper operation and should be performed by qualified personnel

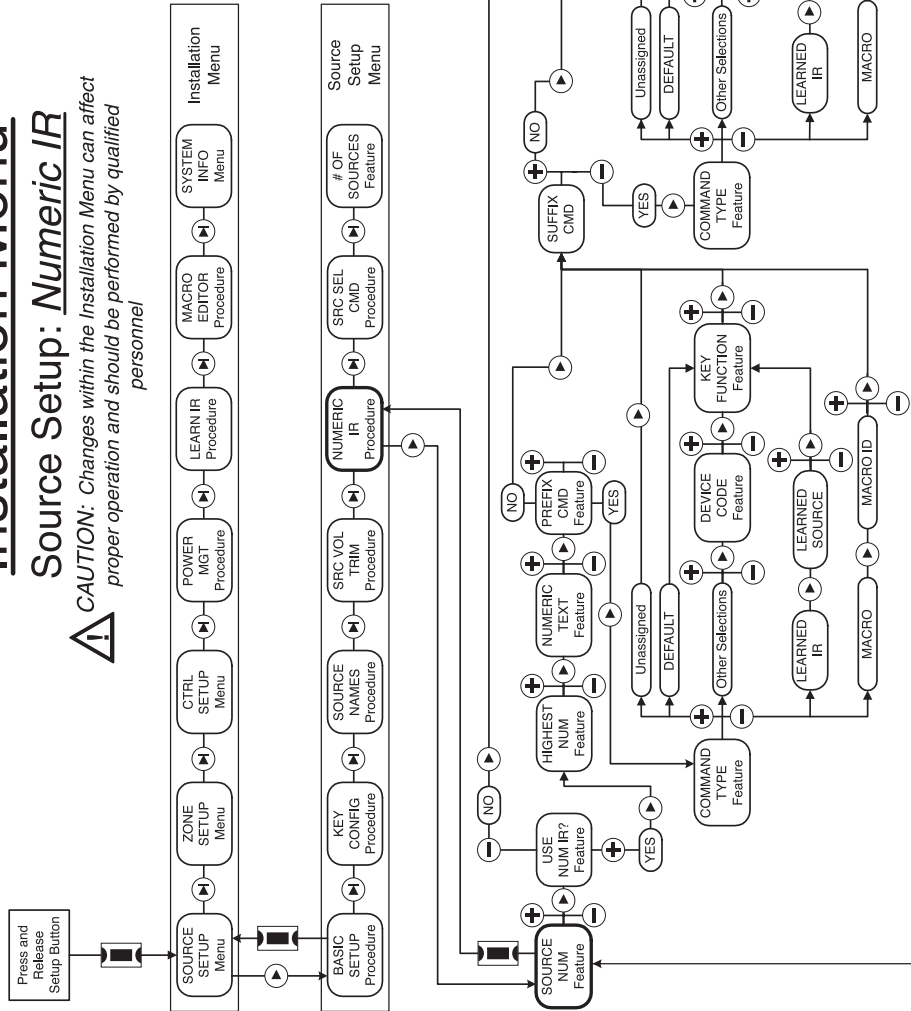







INSTALLER

SETUP MENU FLOW CHARTS

Source Setup: Source Select Command/# of Sources

NOTE: Diagram shows UNO-S2 keypad buttons used in the programming procedure.
 Corresponding UNO-S1 keypad buttons:

UNO-S1:   
 UNO-S2:   

Installation Menu

Source Setup: Source Select Command & Number of Sources

CAUTION: Changes within the Installation Menu can affect proper operation and should be performed by qualified personnel

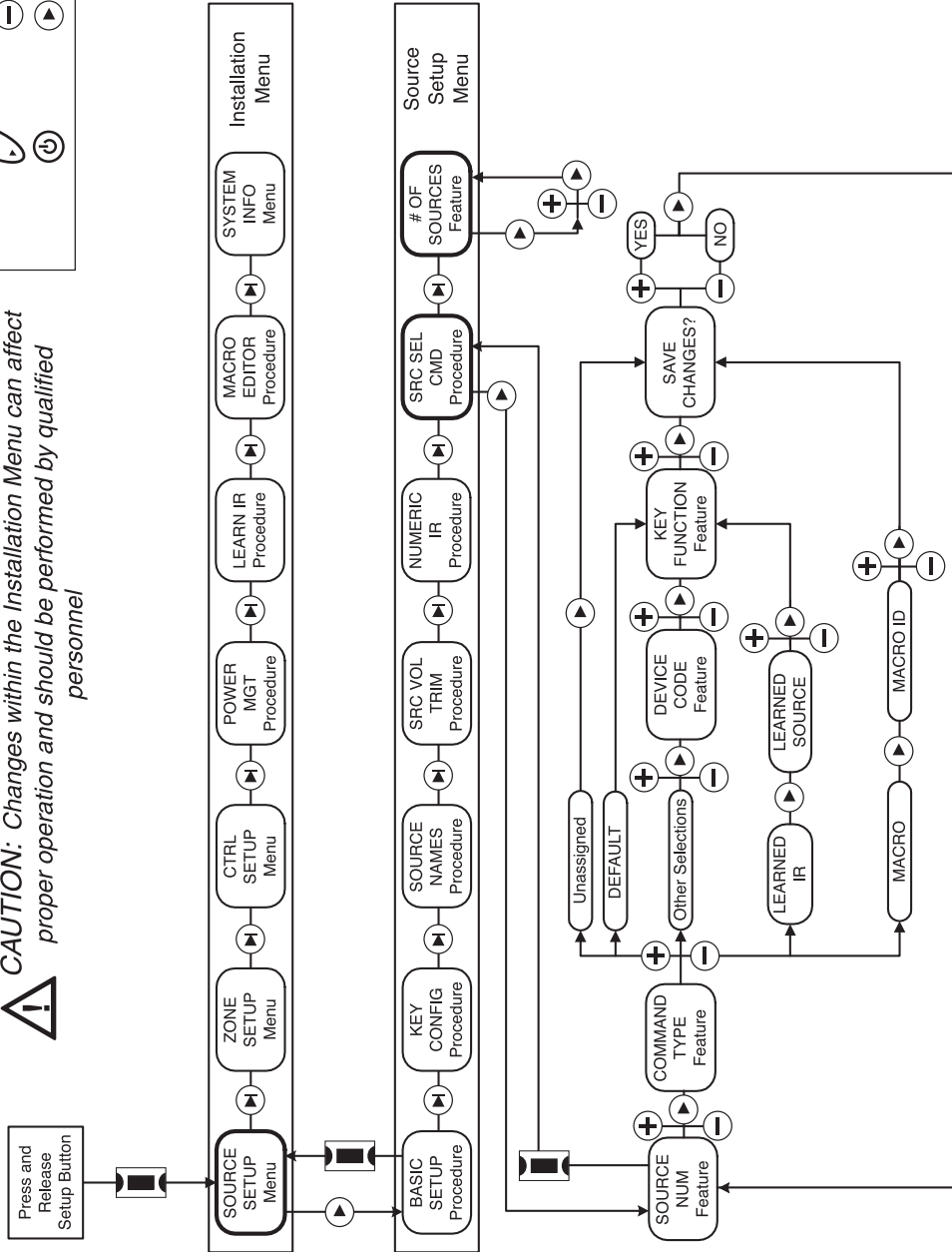



Installation Menu

Zone Setup

CAUTION: Changes within the Installation Menu can affect proper operation and should be performed by qualified personnel!

Press and Release Setup Button

NOTE: Diagram shows UNO-S2 keypad buttons used in the programming procedure.
Corresponding UNO-S1 keypad buttons:

UNO-S1:  UNO-S2: 

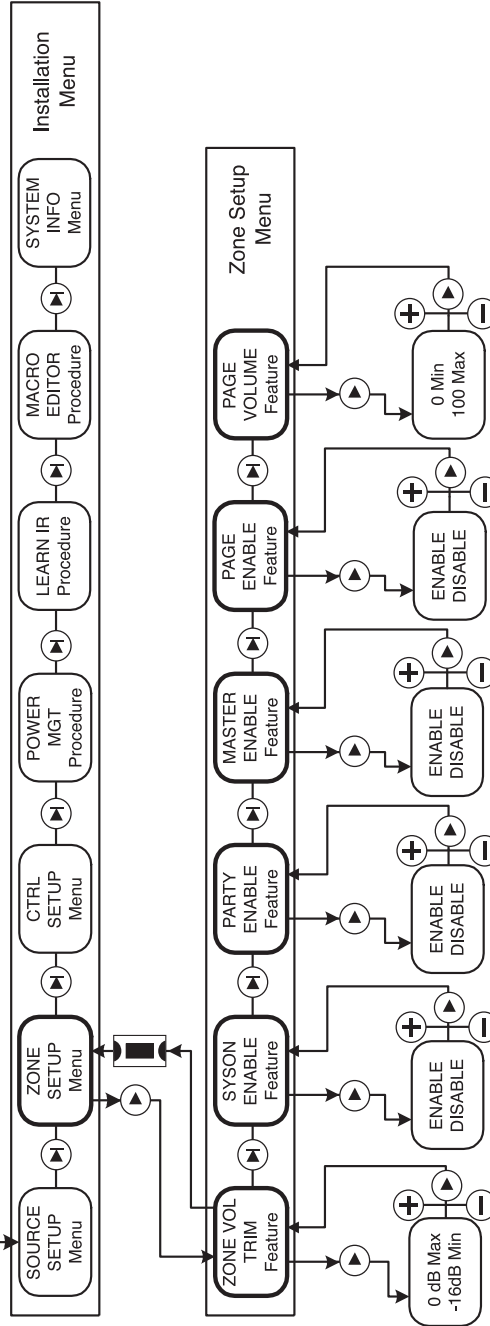

INSTALLER SETUP MENU FLOW CHARTS







Zone Setup

INSTALLER

SETUP MENU FLOW CHARTS

Controller Setup

NOTE: Diagram shows UNO-S2 keypad buttons used in the programming procedure.
 Corresponding UNO-S1 keypad buttons:

UNO-S1:   
 UNO-S2:   

Installation Menu

Controller Setup

CAUTION: Changes within the Installation Menu can affect proper operation and should be performed by qualified personnel

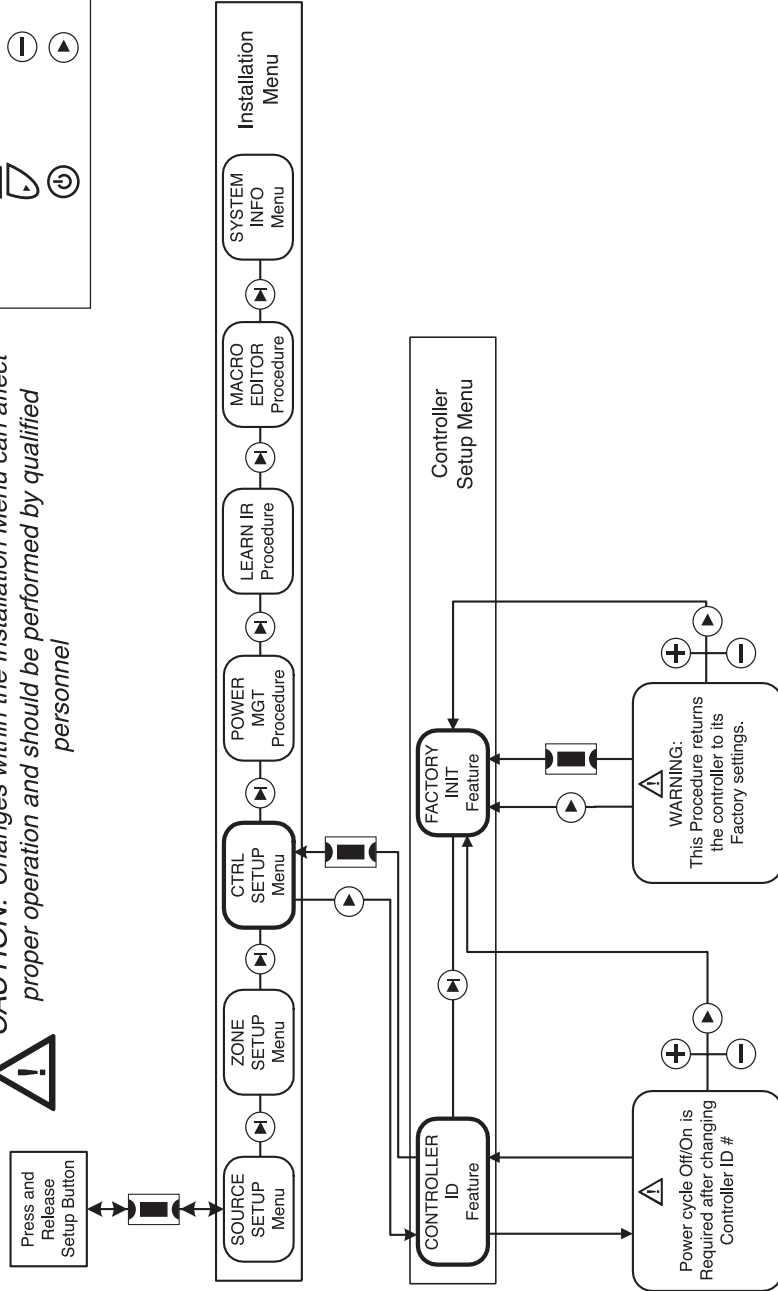

INSTALLER SETUP MENU FLOW CHARTS

Power Management

NOTE: Diagram shows UNO-S2 keypad buttons used in the programming procedure.
Corresponding UNO-S1 keypad buttons:

UNO-S1: [Up], [Down], [Left], [Right]

UNO-S2: [Up], [Down], [Left], [Right]

Installation Menu

Power Management

CAUTION: Changes within the Installation Menu can affect proper operation and should be performed by qualified personnel!

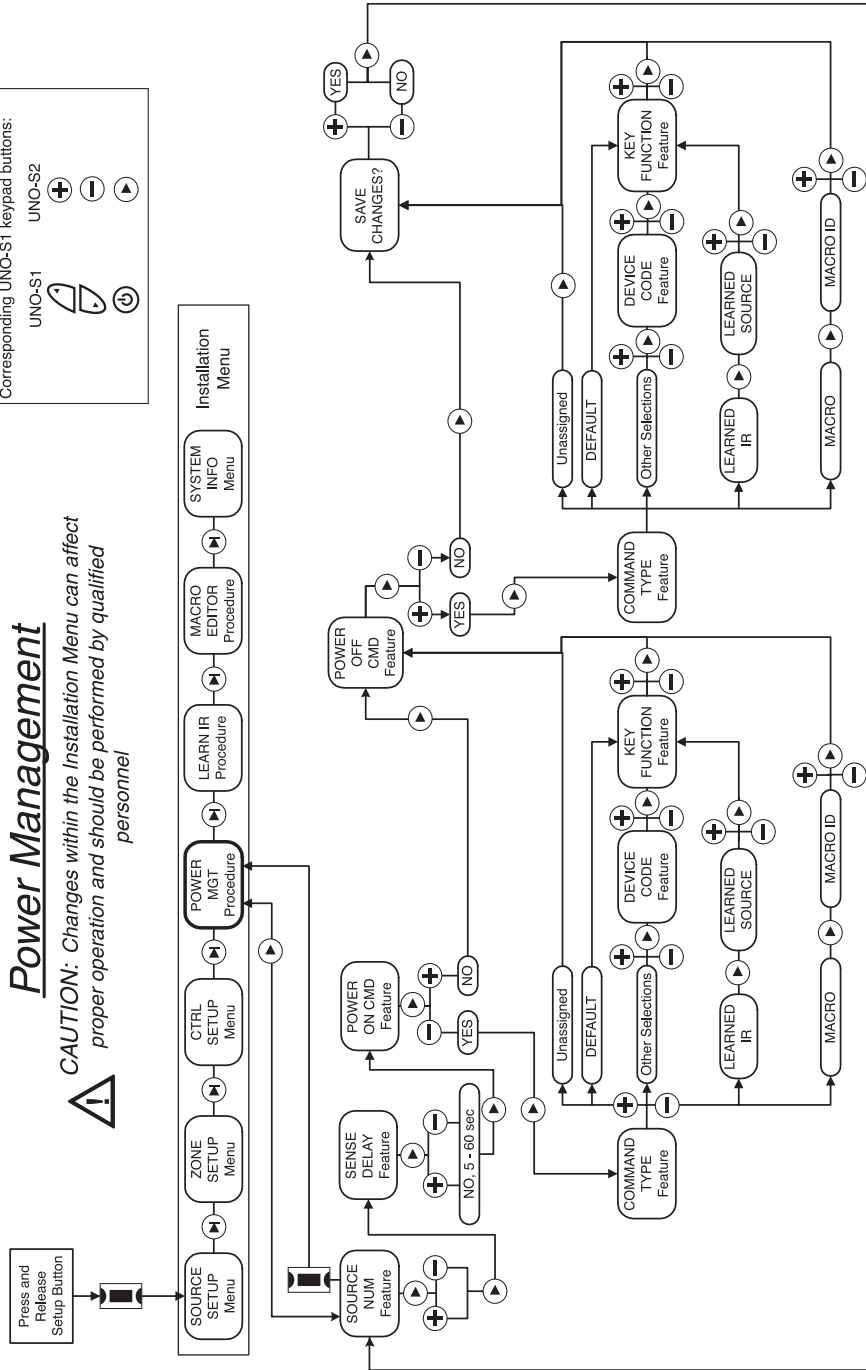



INSTALLER SETUP MENU FLOW CHARTS

Learn IR

Installation Menu Learn IR

CAUTION: Changes within the Installation Menu can affect proper operation and should be performed by qualified personnel

NOTE: Diagram shows UNO-S2 keypad buttons used in the programming procedure.
Corresponding UNO-S1 keypad buttons:

UNO-S1:  UNO-S2: 

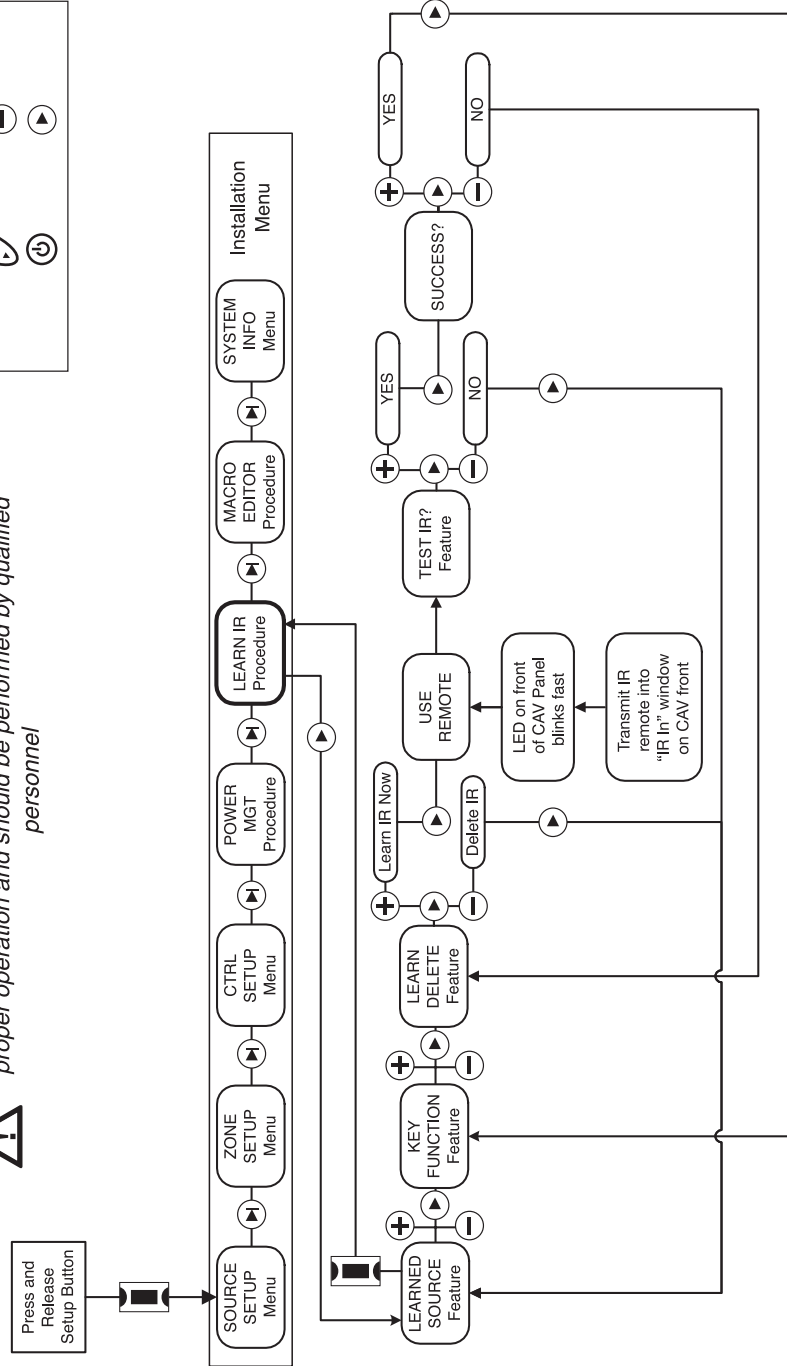

Installation Menu

Macro Editor

CAUTION: Changes within the Installation Menu can affect proper operation and should be performed by qualified personnel!

Press and Release Setup Button

NOTE: Diagram shows UNO-S2 keypad buttons used in the programming procedure.
 Corresponding UNO-S1 keypad buttons:

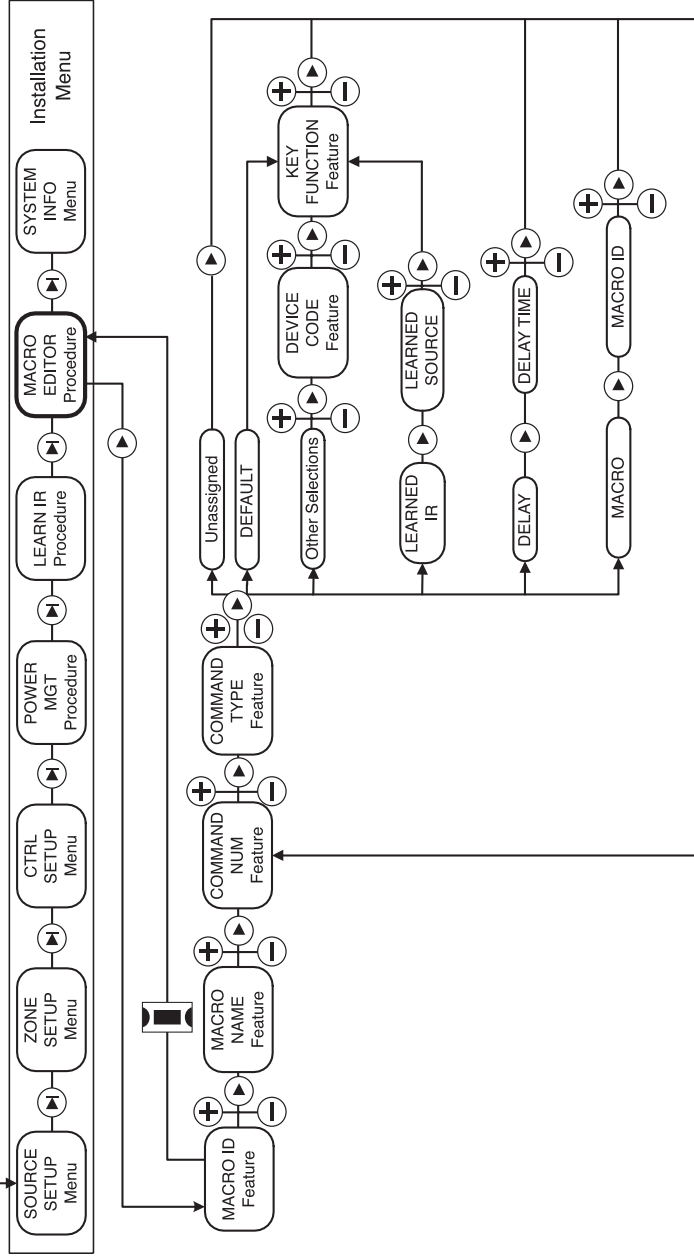
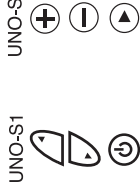

INSTALLER SETUP MENU FLOW CHARTS

Macro Editor

INSTALLER SETUP MENU FLOW CHARTS

System Info

NOTE: Diagram shows UNO-S2 keypad buttons used in the programming procedure.

Corresponding UNO-S1 keypad buttons:

UNO-S1	UNO-S2

Installation Menu

System Info Menu

CAUTION: Changes within the Installation Menu can affect proper operation and should be performed by qualified personnel

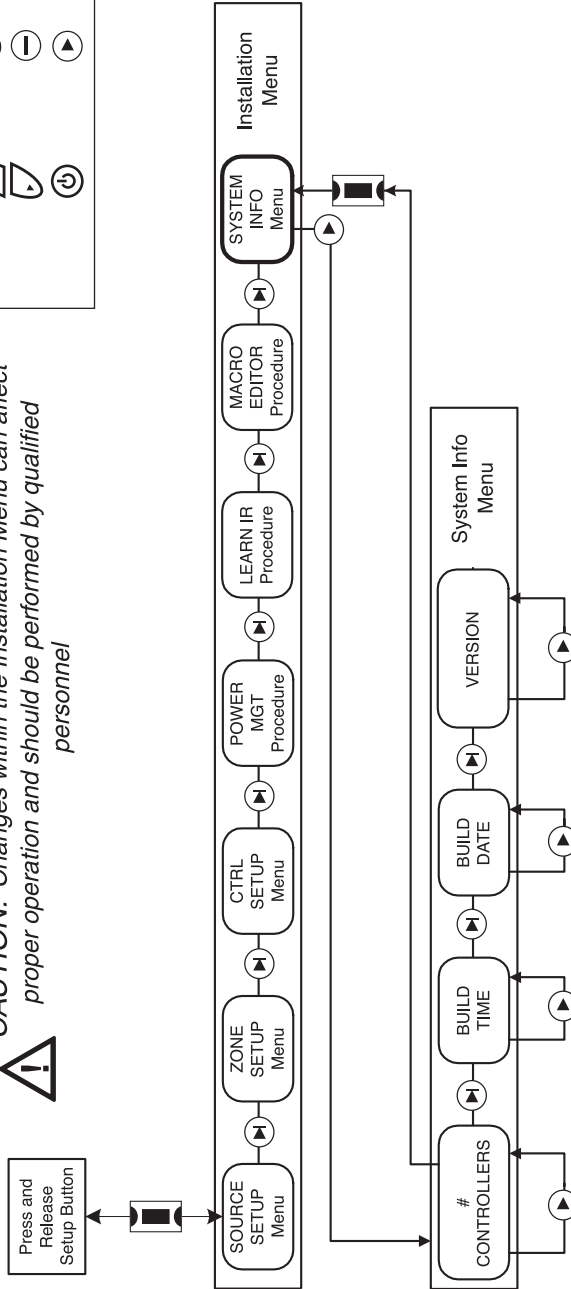

INSTALLER

KEYPAD DIAGNOSTIC MENU

UNO Keypad Diagnostics Menu

The Diagnostics Menu allows the installer to run a diagnostic check on the keypad and to verify the firmware version. The Diagnostics Menu also contains the update firmware procedure for updating the UNO-S1 and UNO-S2's firmware.

To access the Diagnostics Menu, press and hold the Setup button on the right side of the keypad until "DIAGNOSTICS" appears on the display. The

menus are outlined in the diagram below.

When finished, press and release the Setup button again (except for the Update Firmware where the power must be cycled).

Note: Do not change Controller ID settings in this menu. Controller ID is set in the Controller Setup menu (see **Controller Setup Menu on page 57**).

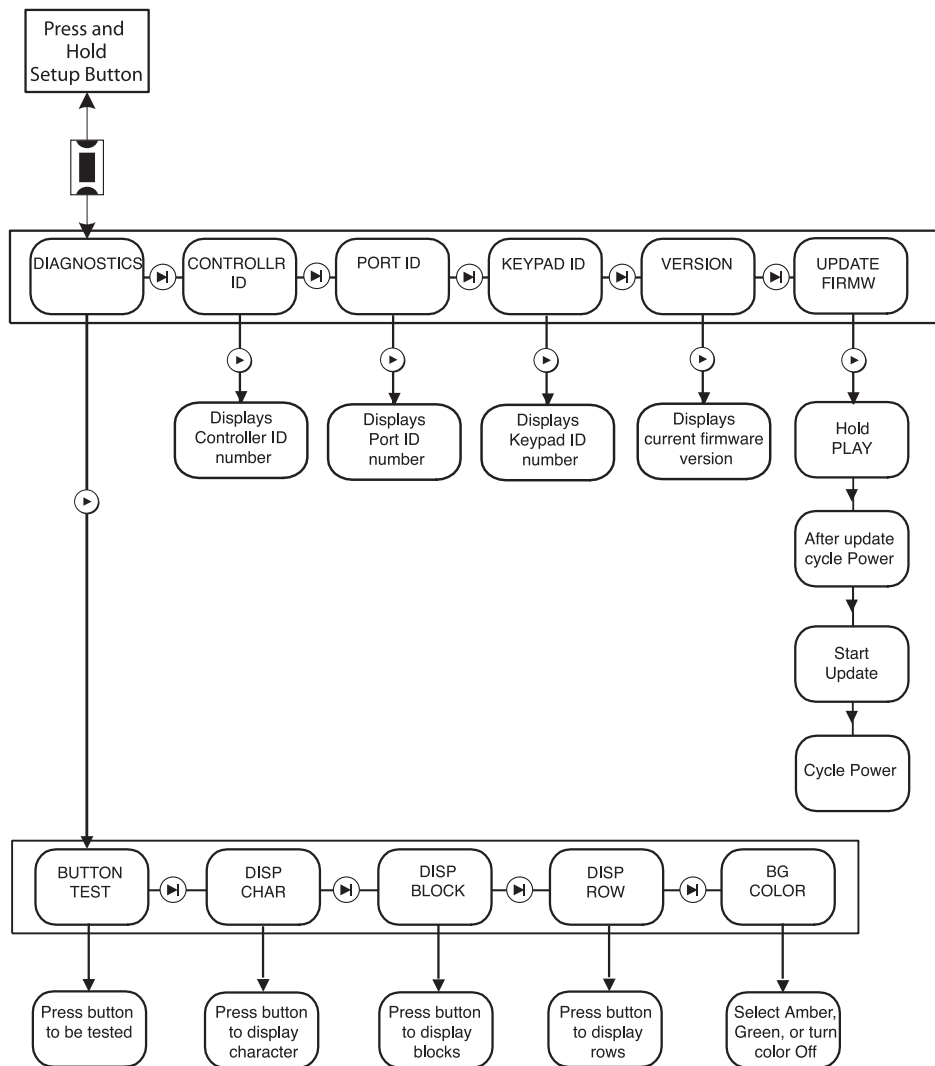

R INSTALLER IR DEVICE CODES

Device Codes for TVs:

Admiral	0093, 0463
Advent	0761, 0842
Aiko	0092
Akai	0030, 0672, 0702, 0812
Albatron	0700, 0843
America Action	0180
Anam	0180
AOC	0030
Apex Digital	0748, 0765, 0767, 0879, 1943
Audiovox	0451, 0180, 0092, 0623
Bell & Howell	0154
BenQ	1032
Bradford	0180
Broksonic	0236, 0463, 1935, 1911
Candle	0030
Carnivale	0030
Carver	0054
Celebrity	0000
Celera	0765
Changhong	0765
Citizen	0060, 0030, 0092
Clarion	0180
Comm'l Solutions	1447, 0047
Contec	0180
Craig	0180
Crosley	0054
Crown	0180
Curtis Mathes	0047, 1147, 1347, 0054, 0154, 0451, 0093, 0060, 0030, 0145, 0166, 0702
CXC	0180
Daewoo	0451, 1661, 0672, 0092, 0661, 0623
Dell	1080
Denon	0145
Dumont	0017
Durabrand	0463, 0180, 0178, 0171, 1034
Electroband	0000
Emerson	0154, 0236, 0463, 0180, 0178, 0171, 1911, 0623
Envision	0030
ESA	0812, 0171
Fisher	0154
Fujitsu	0853, 0809, 0683
Funai	0180, 0171, 1904
Futuretech	0180
Gateway	1756, 1755
GE	1447, 0047, 1147, 1347, 0051, 0451, 0178, 1922, 1917
Gibraltar	0017, 0030
Go Video	0886
GoldStar	0030, 0178
Grumpy	0180
Haier	1034
Hallmark	0178
Harley Davidson	1904
Harman/Kardon	0054
Harvard	0180
Havermy	0093
Helios	0865
Hello Kitty	0451
Hisense	0748
Hitachi	1145, 0145, 1960, 1904
Hyundai	0849
Infinity	0054
Inteq	0017

JBL	0054
JCB	0000
Jensen	0761
JVC	0053, 1253, 1923, 0731
KEC	0180
Kenwood	0030
KLH	0765, 0767
KTV	0180, 0030
LG	0178, 0700, 0856
Lloyd's	1904
LXI	0047, 0054, 0154, 0156, 0178
Magnavox	1454, 0054, 0030, 0706, 1904, 1254
Marantz	0054, 0030
Matsushita	0250
Maxent	1755
Megapower	0700
Megatron	0178, 0145
Memorex	0154, 0463, 0150, 0178, 1911
MGA	0150, 0030, 0178
Midland	0047, 0017, 0051
Mitsubishi	0093, 1250, 0150, 0178, 1917
Monivision	0843, 0700
Motorola	0093
MTC	0060, 0030
Multitech	0180
NAD	0156, 0178, 0866
NEC	0030
Nikko	0030, 0178, 0092
Norcent	0748, 0824
NTC	0092
Onwa	0180
Optimus	0154, 0250, 0166
Optonica	0093
Orion	0236, 0463, 1911, 1463
Panasonic	0250, 0051, 1941
Penney	0047, 0156, 0051, 0060, 0030, 0178, 1347
Philco	0054, 0030
Philips	1454, 0054, 1961, 0690
Pilot	0030
Pioneer	0166, 0679, 0866
Portland	0092
Prima	0761
Princeton	0700
Prism	0051
Proscan	1447, 0047, 1347, 1922
Proton	0178
Pulsar	0017
Quasar	0250, 0051
Radio Shack	0047, 0154, 0180, 0030, 0178, 1904
RCA	1447, 0047, 1047, 1347, 1917, 0679, 1247, 1547, 1948, 0090, 1147, 1922
Realistic	0154, 0180, 0030, 0178
Runco	0017, 0030
Sampo	0030, 1755
Samsung	0060, 0812, 0702, 0030, 0178, 0766, 1959, 1060
Sansul	0463, 1935, 1911, 1904
Sanyo	0154, 0088
Scotch	0178
Scott	0236, 0180, 0178
Sears	0047, 0054, 0154, 0156, 0178, 0171, 1904
Sharp	0093, 1917
Sheng Chia	0093

Sony	1100, 0000, 1904
Soundesign	0180, 0178
Squareview	0171
SSS	0180
Starlite	0180
Studio Experience	0843
Supreme	0000
SVA	0748, 0865
Sylvania	0054, 0030, 0171
Symphonic	0180, 0171, 1904
Tandy	0093
Tatung	1756
Technics	0051, 0250
Techwood	0051
Teknika	0054, 0180, 0150, 0060, 0092
Telefunken	0702
Thomas	1904
TMK	0178
TNCi	0017
Toshiba	0154, 0156, 0060, 1256, 1156, 1656, 1356, 1945, 1935
TVS	0463
V Inc.	1756
Vector Research	0030
Victor	0053
Vidikron	0054
Vidtech	0178
Viewsonic	1755
Wards	0054, 0030, 0178, 0866, 1156
Waycon	0156
Westinghouse	0889
WhiteWestinghouse	0463, 0623
Yamaha	0030
Zenith	0017, 0463, 0178, 1911, 0092, 1904

Device Codes for Cable:

ABC	0003, 0008
Americast	0899
Bell South	0899
Clearmaster	0883
ClearMax	0883
Coolmax	0883
Director	0476
General Instrument	0003, 0476, 0810, 0276
GoldStar	0144
Hamlin	0009, 0273
Jerrold	0003, 0276, 0476, 0810
Memorex	0000
Motorola	0476, 0276, 0810, 1254, 1376
Multitech	0883
Pace	0237, 1877
Panasonic	0000, 0107
Paragon	0000
Philips	0317, 1305
Pioneer	0144, 0533, 0877, 1877
Pulsar	0000
Quasar	0000
RadioShack	0883
Regal	0273, 0279
Runco	0000
Samsung	0144
Scientific Atlanta	0008, 0477, 0877, 1877
Sony	1006

(continued next page)

INSTALLER IR DEVICE CODES

Device Codes for Cable: (cont'd)

Starcom	0003
Supercable	0276
Supermax	0883
Torx	0003
Toshiba	0000
Tristar	0883
V2	0883
Viewmaster	0883
Vision	0883
Vortex View	0883
Zenith	0000, 0525, 0899

Device Codes for Video Acc:

ABS	1272
Alienware	1272
CyberPower	1272
D-Link	1554
Escent	1151, 1371, 1370, 1373, 1372
Gateway	1272
Hewlett Packard	1272, 1267
Howard Computers	1272
iBUYPOWER	1272
LG	1415
Linksys	1365
Media Center PC	1272
Microsoft	1272
Mind	1272
Motorola	1363
Northgate	1272
Panasonic	1120
Pioneer	1010
Samsung	1190, 1490
Sensory Science	1126
Sharp	1010
SMC	1456
Sony	1272, 1324, 1364
Systemax	1272
Tagar Systems	1272
Toshiba	1272
Touch	1272
Viewsonic	1272, 1329
ZT Group	1272

Device Codes for SAT/DSS:

AlphaStar	0772
Century	0856
Chaparral	0216
Crossdigital	1109
DirecTV	0392, 0566, 0639, 1639, 1142, 0247, 0749, 1749, 0724, 0819, 1856, 1076, 1109, 0099, 1640, 1108, 1392, 1442, 1414
Dish Network Sys	1005, 0775, 1775, 1505
Dishpro	1005, 0775, 1505, 1775
Echostar	1005, 0775, 1775, 1505
Expressvu	0775, 1775
GE	0566
General Instrument	0869
GOI	0775, 1775
Hisense	1535

Hitachi	0819, 1250
HTS	0775, 1775
Hughes Net. Sys.	0749, 1142, 1749, 1442
HLo	1535
JVC	0775, 1775
LG	1414
Magnavox	0724, 0722
Memorex	0724
Mitsubishi	0749
Motorola	0869
Next Level	0869
Panasonic	0247, 0701
Paysat	0724
Philips	1142, 0749, 1749, 0724, 1076, 0722, 0099, 1442, 0856
Proscan	0392, 0566
Proton	1535
RadioShack	0869
RCA	0392, 0566, 0143, 0855, 1392
Samsung	1276, 1109, 1108
Sony	0639, 1639, 1640
Star Choice	0869
Tivo	1142, 1442
Toshiba	0749, 1749, 0790, 1285
UltimateTV	1392, 1640
Uniden	0724, 0722
US Digital	1535
USDTV	1535
Voom	0869
Zenith	0856, 1856

Device Codes for VCRs:

ABS	1972
Admiral	0048, 0209
Adventura	0000
Aiko	0278
Alwa	0037, 0000
Akai	0041
Alienware	1972
America Action	0278
American High	0035
Asha	0240
Audiovox	0037, 0278
Beaumarck	0240
Bell & Howell	0104
Broksonic	0184, 0121, 0209, 0002, 0479
Calix	0037
Canon	0035
Carver	0081
CCE	0072, 0278
Citizen	0037, 0278
Colt	0072
Craig	0037, 0047, 0240, 0072
Curtis Mathes	0060, 0035, 0162, 0041
Cybernex	0240
CyberPower	1972
Daewoo	0045, 0278
Dell	1972
Denon	0042
DirecTV	0739
Durabrand	0039, 0038
Dynatech	0000
Electrohome	0037
Electrohome	0037
Emerex	0032

Emerson	0037, 0184, 0000, 0121, 0043, 0209, 0002, 0278, 0479
Fisher	0047, 0104
Fuji	0035, 0033
Funai	0000
Garrard	0000
Gateway	1972
GE	0035, 0060, 0240
Go Video	0432
GoldStar	0037, 0038
Gradiente	0000
Harley Davidson	0000
Harman/Kardon	0081, 0038
Harwood	0072
Hewlett Packard	1972
Hi-Q	0047
Hitachi	0000, 0042, 0041, 0089
Howard Computers	1972
Hughes Net. Sys.	0042, 0739
iBUYPOWER	1972
Jensen	0041
JVC	0067, 0041
KEC	0037, 0278
Kenwood	0067, 0041, 0038
KLH	0072
Kodak	0035, 0037
Lloyd's	0000
Logik	0072
LXI	0037
Magnavox	0035, 0039, 0081, 0000, 0149
Magnin	0240
Marantz	0035, 0081
Marta	0037
Matsushita	0035, 0162
Media Center PC	1972
MEI	0035
Memorex	0035, 0162, 0037, 0048, 0039, 0047, 0240, 0000, 0104, 0209, 0479
MGA	0240, 0043
MGN Technology	0240
Microsoft	1972
Mind	1972
Minolta	0042
Mitsubishi	0067, 0043
Motorola	0035, 0048
MTC	0240, 0000
Multitech	0000, 0072
NEC	0104, 0067, 0041, 0038
Nikko	0037
Noblex	0240
Northgate	1972
Olympus	0035
Optimus	1062, 0162, 0037, 0048, 0104, 0432
Orion	0184, 0209, 0002, 0479
Panasonic	1062, 0035, 0162, 0225, 0616
Penney	0035, 0037, 0240, 0042, 0038
Pentax	0042
Philco	0035
Philips	0035, 0081, 0618, 0739
Pilot	0037
Pioneer	0067
Polk Audio	0081
Profitronic	0240
Proscan	0060
Protec	0072

(continued next page)

R INSTALLER IR DEVICE CODES

Device Codes for VCRs: (cont'd)

Pulsar	0039
Quasar	0035, 0162
Radio Shack	0000
Radix	0037
Randex	0037
RCA	0060, 0240, 0042, 0149, 0880
Realistic	0035, 0037, 0048, 0047, 0000, 0104
ReplayTV	0616
Runco	0039
Samsung	0045, 0240
Sanky	0048, 0039
Sansui	0000, 0067, 0209, 0041, 0479
Sanyo	0047, 0240, 0104
Scott	0184, 0045, 0121, 0043
Sears	0035, 0037, 0047, 0000, 0042, 0104
Sharp	0048
Shintom	0072
Shogun	0240
Singer	0072
Sonic Blue	0616
Sony	0035, 0032, 0033, 0000, 0636, 1972
STS	0042
Sylvania	0035, 0081, 0000, 0043
Symphonic	0000
Systemax	1972
Tagar Systems	1972
Tatung	0041
Teac	0000, 0041
Technics	0035, 0162
Teknika	0035, 0037, 0000
Thomas	0000
Tivo	0618, 1503, 0739, 0636
TMK	0240
Toshiba	0045, 0043, 1008, 1972, 1503
Totevision	0037, 0240
Touch	1972
Unitech	0240
Vector	0045
Vector Research	0038
Video Concepts	0045
Videomagic	0037
Videosonic	0240
Viewsonic	1972
Villain	0000
Wards	0035, 0060, 0048, 0047, 0081, 0000, 0042, 0240, 0072, 0149
White Westinghouse	0209, 0072
XR-1000	0035, 0000, 0072
Yamaha	0038
Zenith	0039, 0033, 0000, 0209, 0479
ZT Group	1972

Device Codes for Laser Disc Players:

Denon	0059
Mitsubishi	0059
NAD	0059
Optimus	0059
Panasonic	0204

Pioneer	0059
Quasar	0204
Sony	0201
Technics	0204

Device Codes for DVD Players:

Allegro	0869
Apex Digital	0672, 0717, 0797, 1061, 0796, 1056, 0794, 1020
Aspire Digital	1168
Blaupunkt	0717
Blue Parade	0571
Broksonic	0695
CineVision	0869
Coby	1086
CyberHome	0816, 1129
Daewoo	0784, 0833, 1172, 0869
Denon	0490
DVD2000	0521
Emerson	0591, 0675
Enterprise	0591
Fisher	0670
Funai	0675
Gateway	1073, 1194, 1158, 1077
GE	0522, 0717
Go Video	0744, 0715, 0833, 1099, 0783, 1075, 1730, 0869, 1158
Greenhill	0717
Hitachi	0573, 0664
Hiteker	0672
Initial	0717
JVC	0558, 0623, 0867
Kenwood	0490, 0534
KLH	0717, 1020
Koss	0651
Lasonic	0798
LG	0591, 0869
Lite-On	1158, 1058
Magnavox	0503, 0539, 0675
Marantz	0539
Memorex	0695
Microsoft	0522
Mintek	0839, 0717
Mitsubishi	1521, 0521
Nesa	0717
Onkyo	0503
Oritron	0651
Panasonic	0490, 1762
Philips	0503, 0539, 0646, 0675, 0885
Pioneer	0525, 0571
Polaroid	1086, 1061
Polk Audio	0539
Proscan	0522
Qwestar	0651
RCA	0522, 0571, 0717, 0822
Rio	0869
Rotel	0623
Sampo	0752
Samsung	0490, 0573, 1075, 0820
Sansui	0695
Sanyo	0695, 0670, 0873
Sharp	0630, 0752
Sherwood	1077
Shinsonic	0533, 0839
Sonic Blue	0869, 1099

Sony	0533, 0864, 1033
Sylvania	0675
Symphonic	0675
Technics	0490
Theta Digital	0571
Toshiba	0503, 1154, 0695
Urban Concepts	0503
US Logic	0839
Xbox	0522
Yamaha	0490, 0539, 0545
Zenith	0503, 0591, 0869

Device Codes for Tuner/Amp:

ADC	0531
Aiwa	0189, 1405, 0158, 0121
Anam	1609, 1074
Audiotronic	1189
Bose	1229
Capetronic	0531
Carver	0189, 1189
Coby	1263
Dell	1383
Denon	1360, 1142
Gateway	1517
Glory Horse	1263
Harman/Kardon	0110, 0189
Hewlett Packard	1181
Integra	0135
JBL	0110
JVC	0074, 1263
Kenwood	1313, 1569, 0027
KLH	1428
Linn	0189
Magnavox	1189, 1269, 0189, 0531
Marantz	1189, 1269, 0039, 0189
MCS	0039
Mitsubishi	1393
Onkyo	0135
Optimus	1023, 0670, 0531, 1074
Panasonic	0039, 0309
Philips	1189, 1269, 0189
Pioneer	1023, 0150, 0014, 0630, 0531
Polk Audio	0189
Proscan	1254
Quasar	0039
RadioShack	1263
RCA	1023, 1609, 1254, 1074, 0531
Rio	1383
Sansui	0189
Sharper Image	1263
Sonic Blue	1383
Sony	1058, 1759, 0158, 1406
Soundesign	0670
Stereophonics	1023
Sunfire	1313
Teac	1074
Technics	1308, 0039, 0309
Thorens	1189
Victor	0074
Wards	0158, 0189, 0014
Yamaha	0176, 1276, 1176

INSTALLER IR DEVICE CODES

Device Codes for Amp and Misc. Audio:

Aiwa	0159
Altec Lansing	1485
Cambridge Sound	1530
Creative	0872
Durabrand	1561
GE	0078
Harman/Kardon	0892
JVC	0331
Left Coast	0892
Lenox	1561
Marantz	0892, 1491
Motorola	1464
Omnifi	1605
Optimus	0395
Philips	0892
Polk Audio	0892
Realistic	0395
Russound	1302
Sony	0159
Soundesign	0078
Victor	0331
Wards	0078
Yamaha	0354

QED	0157
Quad	0157
Quasar	0029
RadioShack	1075
RCA	0032, 0305, 0179, 0053, 0420
Realistic	0420, 0179
Rotel	0157, 0420
SAE	0157
Sansui	0157, 0305
Sanyo	0087, 0179
Scott	0305
Sears	0305
Sharp	0861, 0037
Sherwood	1067
Sonic Frontiers	0157
Sony	0490, 0000, 0100
Soundesign	0145
Symphonic	0305
TAG McLaren	0157
Tascam	0420
Teac	0420
Technics	0029
Victor	0072
Wards	0157, 0053
Yamaha	0888, 0036

Device Codes for CD Players:

Aiwa	0157
Burmester	0420
Calif. Audio Labs	0029
Carver	0157, 0179
Denon	0873, 0003
DKK	0000
DMX Electronics	0157
Emerson	0305
Fisher	0179
Garrard	0420
Genexxa	0032, 0305
Harman/Kardon	0157, 0173
Hitachi	0032
Integra	0101
JVC	0072
Kenwood	0681, 0028, 0037, 0190
KLH	1318
Krell	0157
Linn	0157
LXI	0305
Magnavox	0157, 0305
Marantz	0029, 0157
MCS	0029
Miro	0000
Mission	0157
MTC	0420
NSM	0157
Onkyo	0868, 0101
Optimus	1063, 0000, 0032, 0037, 1075, 0179, 0145, 0420, 0087, 0305
Panasonic	0029
Parasound	0420
Philips	0157
Pioneer	1063, 0032, 0305
Polk Audio	0157
Proton	0157

Device Codes for Home Control:

Accutek	1215
Bionaire	1215
Frigidaire	1333
GE	0240
GoldStar	1537
Holmes	1215
Lasko	0846
LG	1537
Lutron	0597
One For All	0167
RadioShack	0240
Russound	1232, 1233
Security System	0167
Sharper Image	0846
Universal X10	0167
Whirlpool	1332
Windmere	1215
X10	0167



SOURCE NAMES

UNO-S1	UNO-S2	UNO-S1	UNO-S2	UNO-S1	UNO-S2
Aux	AUX		CustomName3	DVD 3	DVD Player 3
Aux 1	AUX 1		CustomName4	FDoor	Front Door
Aux 2	AUX 2		CustomName5	Hers	Her Music
Blues	Blues		CustomName6	His	His Music
Cable	Cable		CustomName7	www.	Intrnet Radio
Cbl 1	Cable 1		CustomName8	Jazz	Jazz
Cbl 2	Cable 2		CustomName9	Kids	Kids Music
Cbl 3	Cable 3		CustomName10	LD	Laser Disk
CDCh	CD Changer	Dance	Dance Music	MSvr	Media Server
CDCh1	CD Changer 1	DigCb	Digitl Cable	MSvr1	Media Svr 1
CDCh2	CD Changer 2	DSS	DSS Receiver	MSvr2	Media Svr 2
CDCh3	CD Changer 3	DSS 1	DSS 1	MSvr3	Media Svr 3
CD	CD Player	DSS 2	DSS 2	MiniD	Mini Disk
CD 1	CD Player 1	DSS 3	DSS 3	Misc	Misc Lrnd IR
CD 2	CD Player 2	DVDCh	DVD Changer	Mood	Mood Music
CD 3	CD Player 3	DVDC1	DVD Changr1	MornM	MorningMusic
Class	Classical	DVDC2	DVD Changr2	MP3	MP3
Compr	Computer	DVDC3	DVD Changr3	Oldes	Oldies
Cntry	Country	DVD	DVD Player	Pop	Pop
	CustomName1	DVD 1	DVD Player 1	RDoor	Rear Door
	CustomName2	DVD 2	DVD Player 2	Relig	Religious

SOURCE NAMES



UNO-S1	UNO-S2	UNO-S1	UNO-S2
RepTV	ReplayTV	Tun 1	Tuner 1
Rock	Rock	Tun 2	Tuner 2
Sat	Satellite	Tun 3	Tuner 3
Sat 1	Satellite 1	TV	TV
Sat 2	Satellite 2	VCR	VCR
Sat 3	Satellite 3	VCR 1	VCR 1
SatRd	Sat Radio	VCR 2	VCR 2
Src 1	Source 1	<XM>	<<<XM>>>
Src 2	Source 2	XM 1	XM 1
Src 3	Source 3	XM 2	XM 2
Src 4	Source 4	XM 3	XM 3
Src 5	Source 5	XM	XM Radio
Src 6	Source 6		
Src 7	Source 7		
Src 8	Source 8		
Spcl	Special		
Tape	Tape		
Tape1	Tape 1		
Tape2	Tape 2		
TiVo	TIVO		
Tuner	Tuner		



SAMPLE SYSTEM CONFIGURATION 1

Six Zones and Six Sources

The configuration shows how the CAV6.6 distributes audio/video throughout the house using six UNO System Keypads and six audio/video source components.

Source Components

The configuration allows for any zone to select any one of the six source inputs.

Keypads

The configuration uses a single UNO-S2 Keypad per zone. Each keypad is connected to the CAV6.6's Keypad Port using the RJ-45 T568A wiring configuration. Each keypad port number corresponds with the zone number. This gives complete control of the zone to one keypad.

The UNO-S2 Keypad can control the source equipment, volume for the zone, source selection, tone control, mute, and other functions. Programmable functions are also possible. The IR receiver on the keypad also allows the SRC2 and other remotes to control not only the zone but also the source equipment.

IR Remote control through Keypad

To control the source components via IR from the UNO-S2 Keypad, an IR emitter must be connected from the source component to the CAV6.6. The emitter is shown connected from the IR receiver on the source component to the source component's IR emitter output port on the rear on the CAV6.6. This type of configuration allows independent control over more than one identical source component. The IR from the remote will be routed to the selected source. When using the SRC2 remote, simply select "UNO" at the top of the remote, select source 1-6 and operate the source.

Speakers

Connect the speakers to the amplified CAV6.6 zones 1 through 6 using a "Home Run" from the individual amplified speaker outputs to the speakers. Use the detachable modular snap speaker connectors which are color coded and labeled for easy installation. For most installations, 16 gauge 4-conductor wire is recommended.

Components List:

- 1 - CAV6.6 Controller
- 6 - UNO-S2 Keypads
- 3 - pair Advantage Iso-Mount™ Speakers
- 3 - pair Advantage Twist & Tilt™ Speakers
- 6 - 845.1 Micro Emitters

SAMPLE SYSTEM CONFIGURATION 1



Six Zones and Six Sources

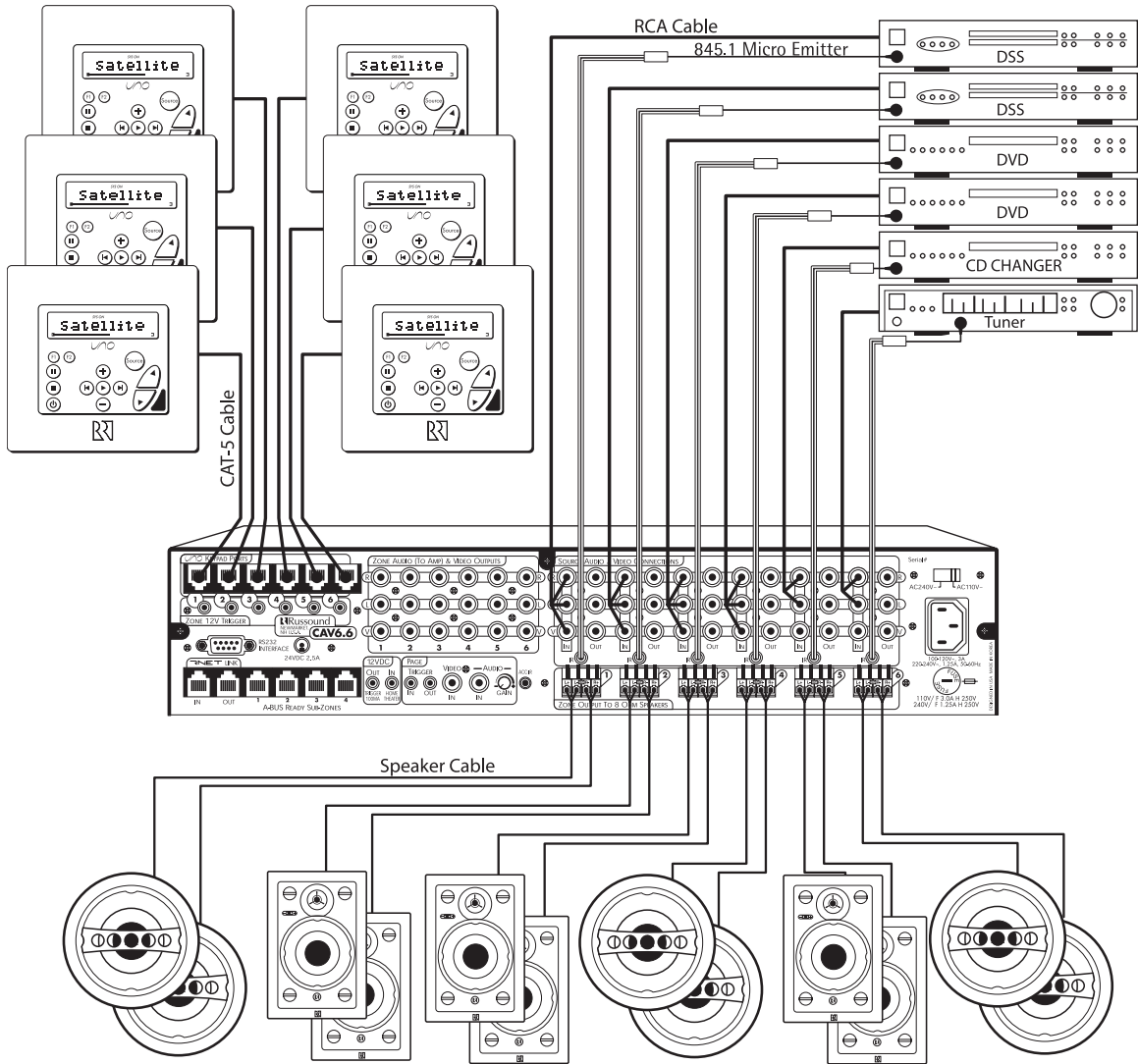

SAMPLE SYSTEM CONFIGURATION 2

Integrate Multiple CAV6.6's

This configuration uses an additional CAV6.6 to add six additional amplified zones, controlled through UNO-S2 Keypads. The source components are connected to both CAV6.6s with RCA cables using the source in/loop out to interconnect the audio/video signals.

RNET Link In and Link Out

Multiple CAV6.6s can be integrated as the two shown in this configuration. An RJ-45 CAT-5 patch cable allows for communication between the two CAV6.6s. System commands such as paging, ALL OFF, ALL ON, IR control, and PC control are transferred from one CAV6.6 to another through the Link In and Link Out Ports using the patch cable.

Source Components

The same six audio/video source components are used for both CAV6.6s. The source components are connected to the Source Audio/Video Input Connections on the first CAV6.6 while the Audio/Video Source Output Connections from the first CAV6.6 are connected to the Source Audio/Video Input Connections on the second CAV6.6.

Keypads

This configuration uses a single UNO-S2 Keypad per zone on each of the CAV6.6s. Each keypad is connected to the UNO System Keypad Port using the CAT-5 T568A RJ-45 wiring configuration. This gives complete control of each of the 12 UNO System Controlled Zones to the corresponding UNO-S2 Keypad.

Individual zone settings such as volume, source selection, on/off, tone control and amplification are controlled through the UNO System Keypad. IR controls for zone and source equipment are controlled through the UNO-S2 Keypad.

Programming Note: *When programming multiple controllers with identical configurations, remove the RNET link cables between controllers before starting any controller programming procedures.*

Components List:

- 2 - CAV6.6 Controllers
- 12 - UNO-S2 Keypads
- 6 - 845.1 Micro Emitters

SAMPLE SYSTEM CONFIGURATION 2



Integrate Multiple CAV6.6's

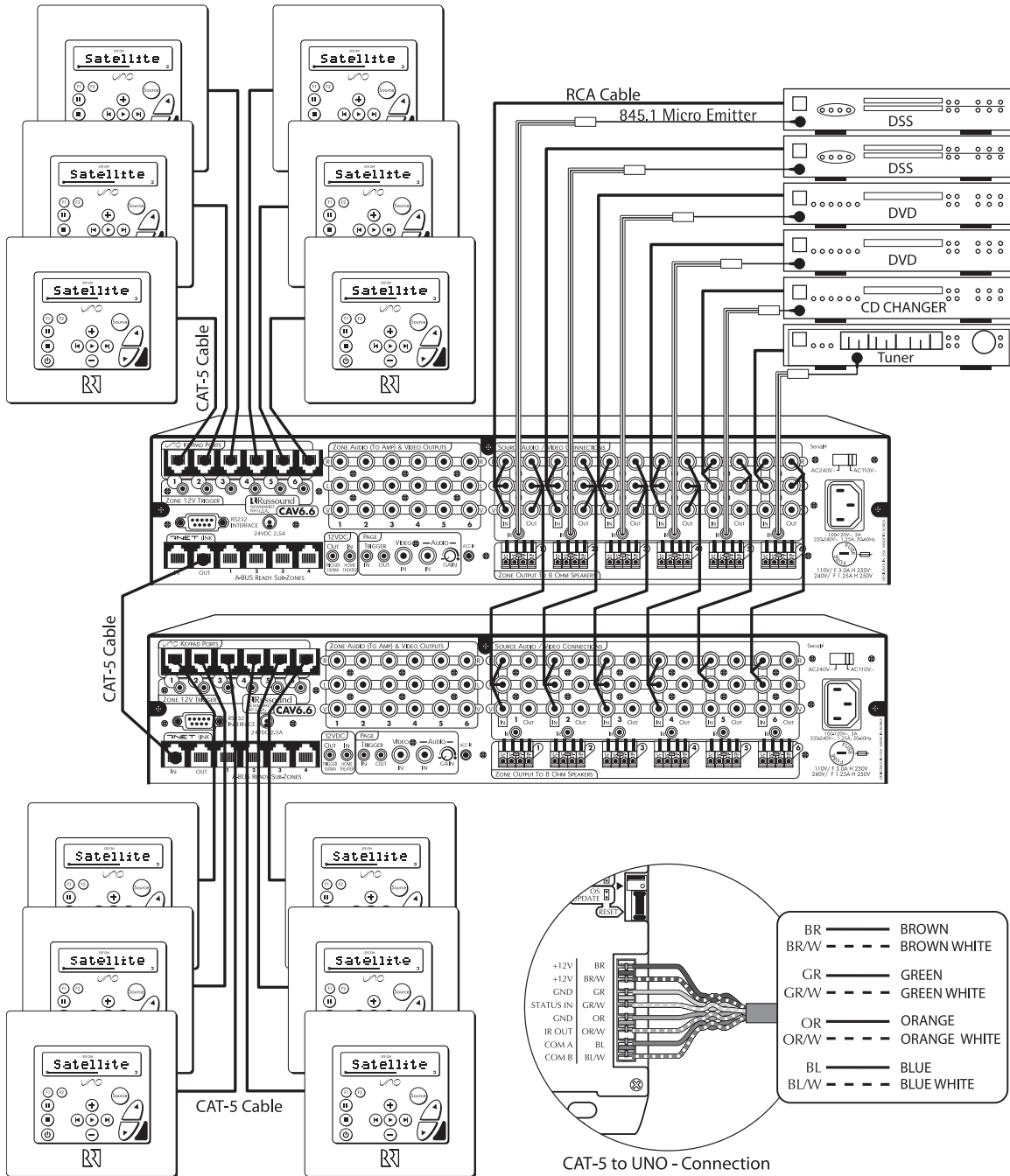

SAMPLE SYSTEM CONFIGURATION 3

Zone Keypad Expansion

This configuration uses a SA-ZX3 Keypad Splitter hub to connect up to three UNO-S2 keypads to one CAV6.6 UNO keypad port. For clean installations, use RJ-45 CAT-5 patch cables with the T568A configuration.

To connect from the SA-ZX3 to an RJ-45 wall plate (optional), use the patch cables to wire for

the wall plate to the keypad. Connect the controller keypad port using the patch cable.

Mount the SA-ZX3 Keypad Splitter hub near the controller using screws or hook and loop fastener. The SA-ZX3 requires a 12VDC 1A power supply, such as the Russound 1201A Power Supply.

Components List:

- 1 - CAV6.6 Controller
- 3 - UNO-S2 Keypads
- 1 - SA-ZX3 Keypad Splitter
- 1 - 1201A 12VDC Power Supply
- 1 - PlateMate™ MOD3D
- 3 - MOD RJ-45 CAT-5

SAMPLE SYSTEM CONFIGURATION 3



Zone Keypad Expansion

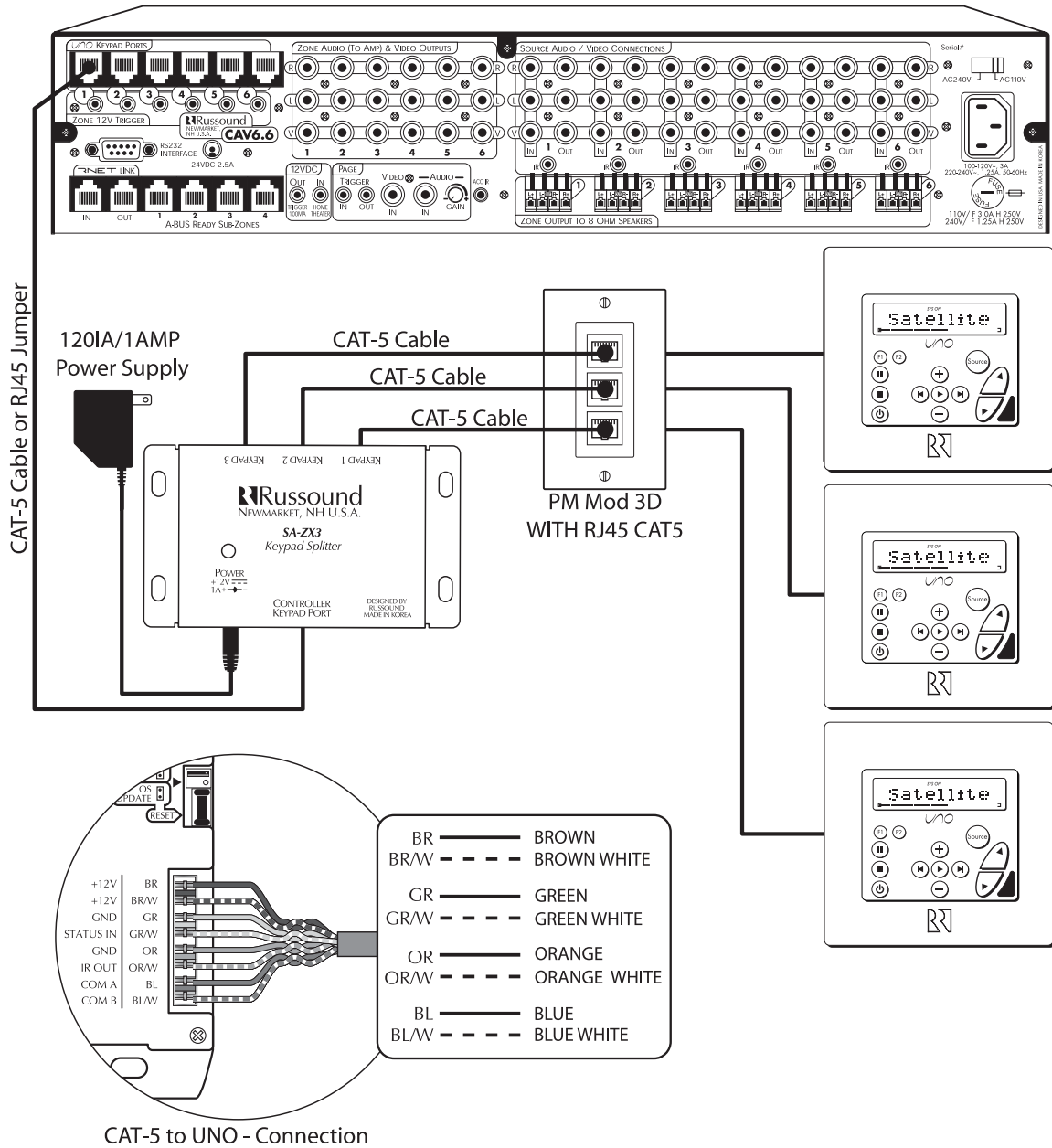

SAMPLE SYSTEM CONFIGURATION 4

A-BUS Ready Sub-Zone Addition

Adding A-BUS allows sub-zoning of the audio distribution of the CAV6.6 system. This configuration demonstrates sub-zoning of the first zone through the use of an A-BUS expansion hub. Only the first four (1-4) CAV6.6 zones can be expanded using the same numbered (1-4) A-BUS Ready Sub-Zone ports.

Powering the A-BUS Ready Sub-Zones

The four A-BUS Ready Sub-Zone ports must be powered by a Russound A-PS 24VDC 2.5A power supply, which is plugged into the 24VDC 2.5A POWER INPUT jack on the rear of the CAV6.6. This is only required when amplified control modules are used without an A-BUS hub.

A-BUS Hub

The A-BUS Hub is used with A-BUS amplified control modules to create additional audio sub-zones and listening options. Using an A-H2 Hub connected to a CAV6.6 A-BUS Ready Sub-Zone port provides two additional A-BUS Sub-Zones. The A-H2 requires a 24VDC 2.5A Power Supply such as the Russound A-PS power supply. Mount the A-H2 near the CAV6.6 and source equipment using screws or hook and loop fastener.

Components List:

- 1 - CAV6.6 Controller
- 1 - A-H2 A-BUS 2-Zone Single Source Surface Mount Hub
- 1 - A-PS Power Supply
- 1 - PlateMate MOD 2S
- 2 - MOD RJ-45 CAT-5
- 1 - A-VC2 Amplified Volume Control
- 1 - A-KP2 Amplified Keypad
- 1 - pair Advantage Iso-Mount Speakers
- 1 - pair Advantage Twist & Tilt Speakers

CAT-5 Connections

The A-H2 Hub connects to the CAV6.6 A-BUS Ready Sub-Zone Port using RJ-45 CAT-5 cables. The cable connects from the CAV6.6 Sub-Zone port to the Expansion Input port on the Hub, then from the Hub keypad output to the RJ-45 wall plate.

Keypad Connections

The A-BUS A-KP2 amplified keypad and the A-VC2 amplified volume control connect to the Hub via the wall plate. Use the CAT-5 T568A RJ-45 wiring configuration for these connections.

Multi-Source Mode Switch

The Multi-Source Mode switch is located on the side of the A-KP2 keypad. It can be set to multi or single source. When the switch is set to "multi," it allows the selection of sources 1 through 4 on the CAV6.6. If "single" is selected, the A-KP2 will not allow source selection from the keypad, but will allow selections by IR remote.

Speakers

The speakers for the A-BUS Ready Sub-Zone are connected to the individual A-BUS amplified control modules. The speaker wire is connected to the keypad using the screw terminal on the rear of the keypad.

SAMPLE SYSTEM CONFIGURATION 4



A-BUS Ready Sub-Zone Addition

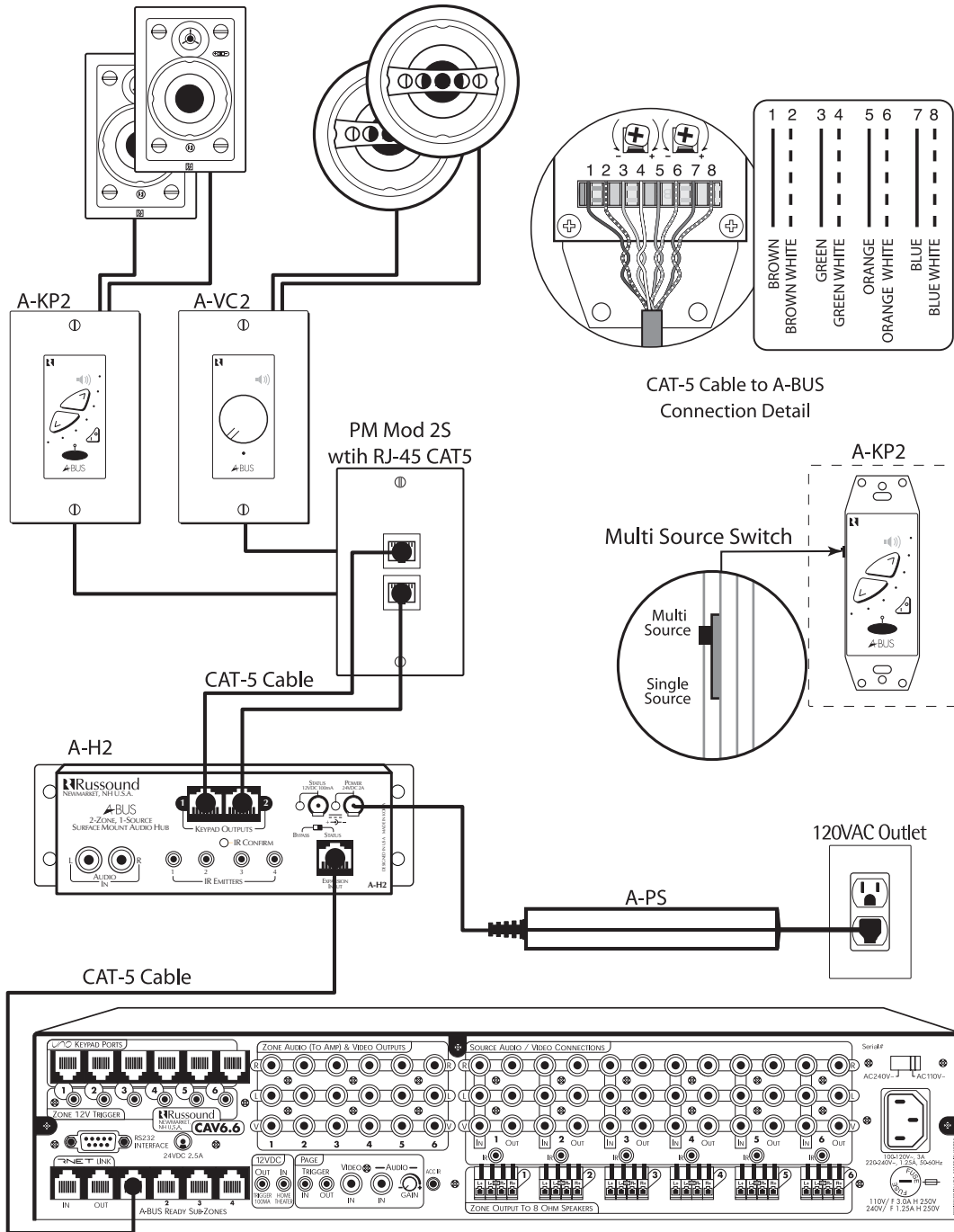

SAMPLE SYSTEM CONFIGURATION 5

Additional Amplification

Additional amplification can be added to the CAV6.6 when more power or more speakers are desired.

This configuration adds an external amplifier to the CAV6.6. The Zone Audio (To Amp) Outputs are variably controlled by the associated UNO-S2 keypad and can be connected to an external amplifier. The figure shows an amplifier used in this manner. The configuration has five zones connected to an additional amplifier with one zone outputting to speakers.

Source Components

In this configuration, three of a possible six audio/video source input components are used. The source components are connected to the source Audio/Video Input Connections at the first three inputs using quality RCA cables.

Zone Audio (To Amp) & Video Outputs

In this option the Zone Audio (To Amp) Outputs for

zones 2 through 6 have the outputs connected to the inputs of an external amplifier. The speakers for these zones are run to the output of the external amplifier for each of these zones.

An amplified subwoofer is attached to the Zone Audio Output for zone 1 while its amplified CAV6.6 output speaker connection is also still intact. This allows the user to increase the output of the bass response while keeping the stereo output from the CAV6.6.

Keypads

The configuration uses a single UNO-S2 Keypad per zone on the CAV6.6. Each keypad is connected to the UNO System Keypad Port using the CAT-5 T568A RJ-45 wiring configuration. This gives complete control of each of the 6 UNO System Controlled Zones to the corresponding UNO-S2 Keypad.

Components List:

- 1 - CAV6.6 Controller
- 6 - UNO-S2 Keypads
- 1 - R1250MC Multi-zone Amplifier
- 3 - pair Advantage Iso-Mount Speakers
- 3 - pair Advantage Twist & Tilt Speakers
- 3 - 845.1 Micro Emitters

SAMPLE SYSTEM CONFIGURATION 5



Additional Amplification

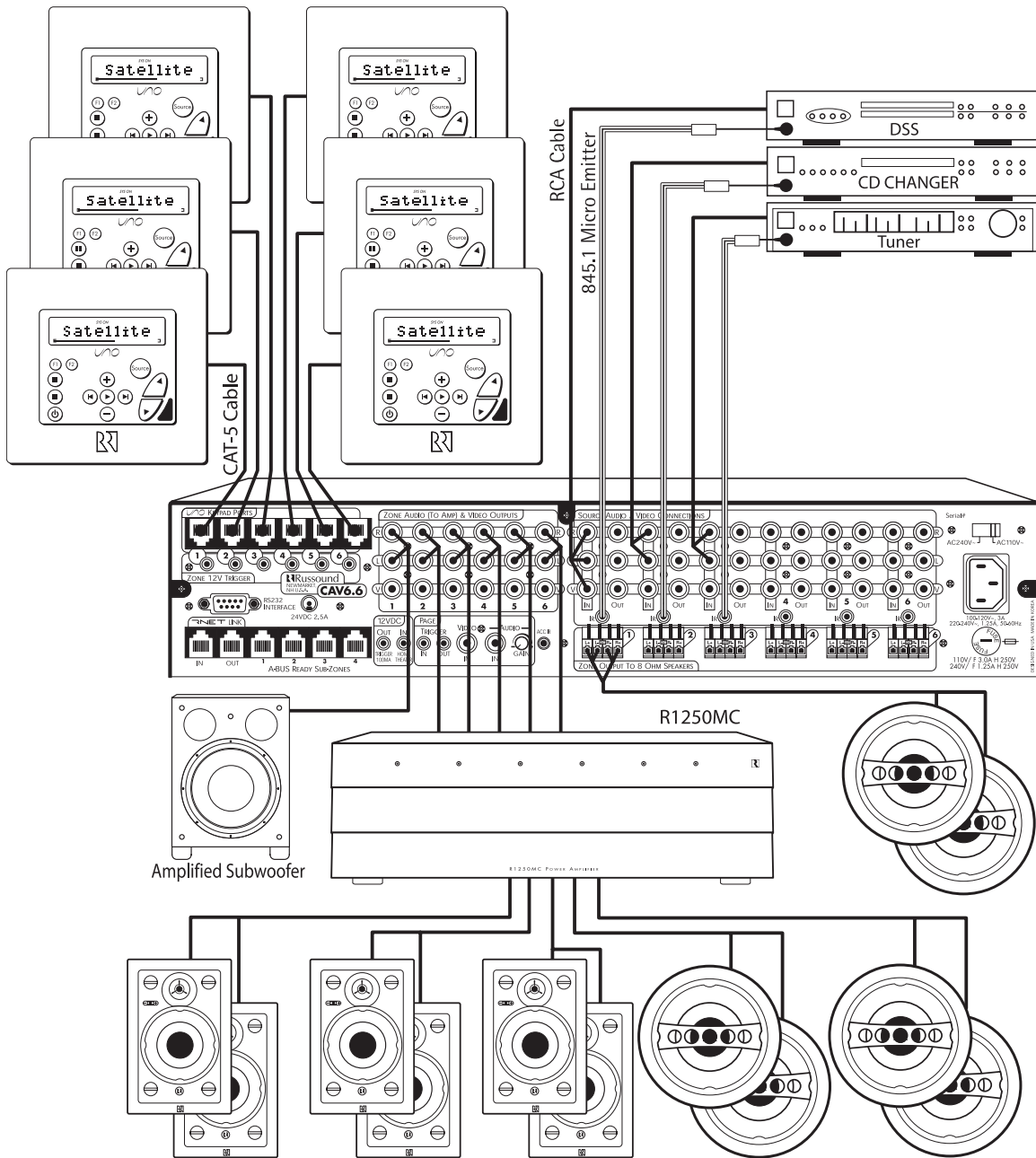

SAMPLE SYSTEM CONFIGURATION 6

Home Theater

Home Theater systems can share sources with a CAV6.6 Controller to provide additional listening and viewing options. In this configuration, the Home Theater Receiver provides a 12VDC signal to the CAV6.6 at the Home Theater 12VDC In Port. The 12VDC signal tells the controller to leave any shared home theater source equipment powered when all CAV6.6 zones are off, temporarily bypassing the source power management feature. The 12VDC connected to the CAV6.6's Home Theater trigger allows the source equipment to be left on.

Source Components

In this configuration, three audio source components are used of a possible six audio/video source inputs. The source components are connected using quality RCA cables to the first three inputs.

Source Loop Outputs

The Source Loop Outputs are connected to the CAV6.6 and to the Home Theater Receiver source inputs using RCA cables. This enables the source equipment to be shared between the two components.

Keypads

Three UNO-S2 Keypads are connected to the CAV6.6 Controller using the CAT-5 T568A RJ-45 wiring configuration. This gives complete control of each of the three zones to the corresponding UNO-S2 Keypad.

Front Left and Right Speakers

Zone 1 uses the same pair of speakers as the Home Theater front main left and right speakers. The amplified output from zone 1 connects to the input on the back of the SRM-2.1 speaker relay module. The Home Theater left and right front main speaker outputs are connected to the input on the front of the SRM-2.1. Zone 1 12V Trigger output is connected to the 12V +/- on the back of the SRM-2.1. When zone 1 is powered on, the SRM-2.1 is triggered allowing audio from zone 1 of the CAV6.6 to power the speakers. When the UNO System Keypad for zone 1 is shut off, 12VDC is no longer provided to the SRM-2.1, and the output of the SRM-2.1 is switched to the Home Theater front left and right amplified speaker output.

Components List:

- 1 - CAV6.6 Controller
- 3 - UNO-S2 Keypads
- 1 - SRM-2.1 Speaker Relay Module
- 1 - pair Advantage Iso-Mount Speakers
- 1 - 846C 12VDC Power Supply
- 3 - 845.1 Micro Emitters

INSTALLER

KEY CODES

TV (HDTV)

KEY FUNCTION	UNO-S1	TV (HDTV)	KEY FUNCTION	UNO-S1	TV (HDTV)
1	1	Digit 1	Pause	Pause	Learned Only
2	2	Digit 2	Record	Recrd	Learned Only
3	3	Digit 3	Menu	Menu	Menu (Picture)
4	4	Digit 4	Menu Up	MenuU	Menu Up, Adjust Up
5	5	Digit 5	Menu Dn	MenuD	Menu Dn, Adjust Dn
6	6	Digit 6	Menu Left	MenuL	Menu Left
7	7	Digit 7	Menu Right	MenuR	Menu Right
8	8	Digit 8	Select	Sel	Menu Select
9	9	Digit 9	Exit	Exit	Exit, Cancel
0	0	Digit 0	Display	Displ	Display, OSD, Info
Volume Up	VolUp	Volume Up	Guide	Guide	Guide
Volume Down	VolDn	Volume Down	Page Up	PageU	Adjust up
Mute	Mute	Mute	Page Down	PageD	Adjust Down
Channel Up	Ch Up	Channel Up	Disk	Disk	Learned Only
Channel Dn	Ch Dn	Channel Down	Plus 10	Pls10	+100
Power	Power	Power On/Off	Open/Close	Op/Cl	Learned Only
Enter	Enter	Channel Enter	Random	Randm	Learned Only
Prev Channel	PrvCh	Last Channel	Track Fwd	TkFwd	Learned Only
TV/Video	TVVid	Learned Only	Track Rev	TkRev	Learned Only
TV/VCR	TVVCR	Learned Only	Sur On/Off	SurOn	Surround On/Off
A/B	A / B	Learned Only	Sur Mode	SurMd	Learned Only
TV/DVD	TVDVD	Learned Only	Surround Up	SurUp	Learned Only
TV/LD	TV LD	Learned Only	Surround Dn	SurDn	Learned Only
Input	Input	TV/Video	PIP	PIP	Learned Only
TV/DSS	TVDSS	Learned Only	PIP Move	PIP M	PIP Move
Play	Play	Learned Only	PIP Swap	PIP S	PIP Swap
Stop	Stop	Learned Only	Program	Progm	Learned Only
Search Fwd	SrchF	Learned Only	Sleep	Sleep	Learned Only
Search Rev	SrchR	Learned Only	On	On	On, Power On/Off

INSTALLER KEY CODES TV (HDTV)

KEY FUNCTION	UNO-S1	TV (HDTV)
Off	Off	Off, Power On/Off
11	11	Learned Only
12	12	Learned Only
13	13	Learned Only
14	14	Learned Only
15	15	Learned Only
16	16	Learned Only
Bright	Brght	Learned Only
Dim	Dim	Learned Only
Close	Close	Learned Only
Open	Open	Learned Only
Halt	Halt	Learned Only
AM/FM	AM/FM	Learned Only
Cue	Cue	Learned Only
Disk Up	DiskU	Learned Only
Disk Down	DiskD	Learned Only
Info	Info	Learned Only
External Src	ExtSr	External Antenna
Live/Intro	Intro	Learned Only
Menu	Menu	Menu (Audio)
Back	Back	Back
Fav Channel	FavCh	Favorite
Display Fmt	DFrmt	Fmt,Wide,16:9,Aspct
SAP	SAP	SAP, CC
Slow	Slow	Learned Only
PIP On	PIPOn	PIP ON
PIP Off	PIPOf	PIP OFF
PIP Freeze	PIPFr	PIP Freeze
PIP Input	PIPIIn	PIP Input

KEY FUNCTION	UNO-S1	TV (HDTV)
PIP Chan Up	PIPCU	PIP Channel Up
PIP Chan Dn	PIPcD	PIP Channel Down
Input 1	In 1	VID1,Video,TVp1
Input 2	In 2	VID2,TVp2
Input 3	In 3	VID3,TVp3
Input 4	In 4	VID4,TVp4
Input 5	In 5	VID5,AV1,VCR,BNC
Input 6	In 6	VID6,AV2,VDR,DVD,DVI
Input 7	In 7	TV, Component
Input 8	In 8	CAB,SAT,S-Video
Input 9	In 9	AV, Tuner
Input 10	In 10	AUX, RGB

INSTALLER

KEY CODES

CABLE

KEY FUNCTION	UNO-S1	CABLE
1	1	Digit 1
2	2	Digit 2
3	3	Digit 3
4	4	Digit 4
5	5	Digit 5
6	6	Digit 6
7	7	Digit 7
8	8	Digit 8
9	9	Digit 9
0	0	Digit 0
Volume Up	VolUp	Volume Up
Volume Down	VolDn	Volume Down
Mute	Mute	Mute
Channel Up	Ch Up	Channel Up
Channel Dn	Ch Dn	Channel Down
Power	Power	Power On/Off
Enter	Enter	Channel Enter
Prev Channel	PrvCh	Last Channel
TV/Video	TVVid	Learned Only
TV/VCR	TVVCR	Learned Only
A/B	A / B	Learned Only
TV/DVD	TVDVD	Learned Only
TV/LD	TV LD	Learned Only
Input	Input	Bypass, A/B
TV/DSS	TVDSS	Learned Only
Play	Play	Play
Stop	Stop	Stop
Search Fwd	SrchF	Fast Forward
Search Rev	SrchR	Rewind

KEY FUNCTION	UNO-S1	CABLE
Pause	Pause	Pause
Record	Recrd	Record
Menu	Menu	Menu, Settings
Menu Up	MenuU	Menu Up
Menu Dn	MenuD	Menu Down
Menu Left	MenuL	Menu Left
Menu Right	MenuR	Menu Right
Select	Sel	Menu Select
Exit	Exit	Exit, Cancel
Display	Displ	Info, Display, OSD
Guide	Guide	Guide
Page Up	PageU	Page Up
Page Down	PageD	Page Down
Disk	Disk	Learned Only
Plus 10	Pls10	+100
Open/Close	Op/Cl	Learned Only
Random	Randm	Learned Only
Track Fwd	TkFwd	Quick Skip, Advance
Track Rev	TkRev	Instant Replay
Sur On/Off	SurOn	Day Down
Sur Mode	SurMd	Learned Only
Surround Up	SurUp	Learned Only
Surround Dn	SurDn	Learned Only
PIP	PIP	Learned Only
PIP Move	PIP M	Learned Only
PIP Swap	PIP S	Learned Only
Program	Progm	Learned Only
Sleep	Sleep	Learned Only
On	On	On, Power On/Off

INSTALLER KEY CODES CABLE

KEY FUNCTION	UNO-S1	CABLE
Off	Off	Off, Power On/Off
11	11	Learned Only
12	12	Learned Only
13	13	Learned Only
14	14	Learned Only
15	15	Learned Only
16	16	Learned Only
Bright	Brght	Learned Only
Dim	Dim	Learned Only
Close	Close	Learned Only
Open	Open	Learned Only
Halt	Halt	Learned Only
AM/FM	AM/FM	Learned Only
Cue	Cue	Learned Only
Disk Up	DiskU	Learned Only
Disk Down	DiskD	Learned Only
Info	Info	Learned Only
External Src	ExtSr	External AV Source
Live/Intro	Intro	Return to Live
Menu	Menu	PPV (Wink)
Back	Back	Back
Fav Channel	FavCh	Favorite
Display Fmt	DFrmt	Help
SAP	SAP	Day Up
Slow	Slow	Learned Only
PIP On	PIPOn	Learned Only
PIP Off	PIPOf	Learned Only
PIP Freeze	PIPFr	Learned Only
PIP Input	PIPIIn	Learned Only

KEY FUNCTION	UNO-S1	CABLE
PIP Chan Up	PIPcU	Learned Only
PIP Chan Dn	PIPcD	Learned Only
Input 1	In 1	A,VID1,Video,TVp1
Input 2	In 2	B,VID2,TVp2
Input 3	In 3	C,VID3,TVp3
Input 4	In 4	VID4,TVp4
Input 5	In 5	VID5,AV1,VCR,BNC
Input 6	In 6	VID6,AV2,VDP,DVD,DVI
Input 7	In 7	TV, Component
Input 8	In 8	CAB,SAT,S-Video
Input 9	In 9	AV, Tuner
Input 10	In 10	AUX, RGB

INSTALLER

KEY CODES

VIDEO ACC

KEY FUNCTION	UNO-S1	VIDEO ACC	KEY FUNCTION	UNO-S1	VIDEO ACC
1	1	Digit 1	Pause	Pause	Pause
2	2	Digit 2	Record	Recrd	Record
3	3	Digit 3	Menu	Menu	Menu, Home
4	4	Digit 4	Menu Up	MenuU	Menu Up
5	5	Digit 5	Menu Dn	MenuD	Menu Dn
6	6	Digit 6	Menu Left	MenuL	Menu Left
7	7	Digit 7	Menu Right	MenuR	Menu right
8	8	Digit 8	Select	Sel	Menu Select
9	9	Digit 9	Exit	Exit	Exit, Cancel, Go
0	0	Digit 0	Display	Displ	Info, Display, OSD
Volume Up	VolUp	Volume Up	Guide	Guide	Guide, View
Volume Down	VolDn	Volume Down	Page Up	PageU	Page Up, Scroll Up
Mute	Mute	Mute	Page Down	PageD	Page Dn, Scroll Dn
Channel Up	Ch Up	Channel Up	Disk	Disk	Learned Only
Channel Dn	Ch Dn	Channel Down	Plus 10	Pls10	+100. +10
Power	Power	Power On/Off	Open/Close	Op/Cl	Learned Only
Enter	Enter	Channel Enter	Random	Randm	Learned Only
Prev Channel	PrvCh	Last Channel	Track Fwd	TkFwd	Skip Up, Next
TV/Video	TVVid	Learned Only	Track Rev	TkRev	Skip Dn, Previous
TV/VCR	TVVCR	Learned Only	Sur On/Off	SurOn	Learned Only
A/B	A / B	Learned Only	Sur Mode	SurMd	Learned Only
TV/DVD	TVDVD	Learned Only	Surround Up	SurUp	Learned Only
TV/LD	TV LD	Learned Only	Surround Dn	SurDn	Learned Only
Input	Input	TV/Video, DTV	PIP	PIP	Learned Only
TV/DSS	TVDSS	Learned Only	PIP Move	PIP M	PIP Move
Play	Play	Play	PIP Swap	PIP S	PIP Swap
Stop	Stop	Stop	Program	Progm	Learned Only
Search Fwd	SrchF	Fast Forward	Sleep	Sleep	Learned Only
Search Rev	SrchR	Rewind	On	On	On, Power On/Off

INSTALLER KEY CODES VIDEO ACC

KEY FUNCTION	UNO-S1	VIDEO ACC	KEY FUNCTION	UNO-S1	VIDEO ACC
Off	Off	Off, Power On/Off	PIP Chan Up	PIP CU	PIP Channel Up
11	11	Learned Only	PIP Chan Dn	PIP CD	PIP Channel Down
12	12	Learned Only	Input 1	In 1	VID1,Video,TVp1
13	13	Learned Only	Input 2	In 2	VID2,TVp2
14	14	Learned Only	Input 3	In 3	VID3,TVp3
15	15	Learned Only	Input 4	In 4	VID4,TVp4
16	16	Learned Only	Input 5	In 5	VID5,AV1,VCR,BNC
Bright	Brght	Learned Only	Input 6	In 6	VID6,AV2,VDP,DVD,DVI
Dim	Dim	Learned Only	Input 7	In 7	TV, Component
Close	Close	Learned Only	Input 8	In 8	CAB,SAT,S-Video
Open	Open	Learned Only	Input 9	In 9	AV, Tuner
Halt	Halt	Learned Only	Input 10	In 10	AUX, RGB
AM/FM	AM/FM	Learned Only			
Cue	Cue	Learned Only			
Disk Up	DiskU	Learned Only			
Disk Down	DiskD	Learned Only			
Info	Info	Learned Only			
External Src	ExtSr	Ext. Antenna, Web			
Live/Intro	Intro	Learned Only			
Menu	Menu	Setup,Prgrm,Options			
Back	Back	Learned Only			
Fav Channel	FavCh	Favorites			
Display Fmt	DFrmt	Fmt,Wide,16:9,Aspct			
SAP	SAP	Language, MTS			
Slow	Slow	Learned Only			
PIP On	PIPOn	PIP ON			
PIP Off	PIPOf	PIP OFF			
PIP Freeze	PIPFr	PIP Freeze			
PIP Input	PIPIn	PIP Input			

INSTALLER

KEY CODES

SAT/DSS

KEY FUNCTION	UNO-S1	SAT/DSS	KEY FUNCTION	UNO-S1	SAT/DSS
1	1	Digit 1	Pause	Pause	Pause
2	2	Digit 2	Record	Recrd	Record
3	3	Digit 3	Menu	Menu	Menu (PVR, Tivo)
4	4	Digit 4	Menu Up	MenuU	Menu Up
5	5	Digit 5	Menu Dn	MenuD	Menu Down
6	6	Digit 6	Menu Left	MenuL	Menu Left
7	7	Digit 7	Menu Right	MenuR	Menu Right
8	8	Digit 8	Select	Sel	Menu Select
9	9	Digit 9	Exit	Exit	Exit, Cancel
0	0	Digit 0	Display	Displ	Info, Display, OSD
Volume Up	VolUp	Volume Up	Guide	Guide	Guide
Volume Down	VolDn	Volume Down	Page Up	PageU	Page Up, ThumbsUp
Mute	Mute	Mute	Page Down	PageD	Page Dn, ThumbsDn
Channel Up	Ch Up	Channel Up	Disk	Disk	Learned Only
Channel Dn	Ch Dn	Channel Down	Plus 10	Pls10	+100
Power	Power	Power On/Off	Open/Close	Op/Cl	Learned Only
Enter	Enter	Channel Enter	Random	Randm	Learned Only
Prev Channel	PrvCh	Last Channel	Track Fwd	TkFwd	Quick Skip, Advance
TV/Video	TVVid	Learned Only	Track Rev	TkRev	Instant Replay
TV/VCR	TVVCR	Learned Only	Sur On/Off	SurOn	Learned Only
A/B	A / B	Learned Only	Sur Mode	SurMd	Learned Only
TV/DVD	TVDVD	Learned Only	Surround Up	SurUp	Learned Only
TV/LD	TV LD	Learned Only	Surround Dn	SurDn	Learned Only
Input	Input	TV/DSS/SAT	PIP	PIP	Learned Only
TV/DSS	TVDSS	Learned Only	PIP Move	PIP M	Learned Only
Play	Play	Play	PIP Swap	PIP S	Learned Only
Stop	Stop	Stop	Program	Progm	Learned Only
Search Fwd	SrchF	Fast Forward	Sleep	Sleep	Learned Only
Search Rev	SrchR	Rewind	On	On	On, Power On/Off

INSTALLER KEY CODES SAT/DSS

KEY FUNCTION	UNO-S1	SAT/DSS
Off	Off	Off, Power On/Off
11	11	Learned Only
12	12	Learned Only
13	13	Learned Only
14	14	Learned Only
15	15	Learned Only
16	16	Learned Only
Bright	Brght	Learned Only
Dim	Dim	Learned Only
Close	Close	Learned Only
Open	Open	Learned Only
Halt	Halt	Learned Only
AM/FM	AM/FM	Learned Only
Cue	Cue	Learned Only
Disk Up	DiskU	Learned Only
Disk Down	DiskD	Learned Only
Info	Info	Learned Only
External Src	ExtSr	External AV Source
Live/Intro	Intro	Return to Live
Menu	Menu	Menu (DTV)
Back	Back	Back
Fav Channel	FavCh	Favorite
Display Fmt	DFrmt	Fmt,Wide,16:9,Aspct
SAP	SAP	Alt/Audio,Lang.,CC
Slow	Slow	Slow
PIP On	PIPOn	Learned Only
PIP Off	PIPOf	Learned Only
PIP Freeze	PIPFr	Learned Only
PIP Input	PIPIn	Learned Only

KEY FUNCTION	UNO-S1	SAT/DSS
PIP Chan Up	PIPcU	Learned Only
PIP Chan Dn	PIPcD	Learned Only
Input 1	In 1	VID1,Video,TVp1
Input 2	In 2	VID2,TVp2
Input 3	In 3	VID3,TVp3
Input 4	In 4	VID4,TVp4
Input 5	In 5	VID5,AV1,VCR,BNC
Input 6	In 6	VID6,AV2,VDP,DVD,DVI
Input 7	In 7	TV, Component
Input 8	In 8	CAB,SAT,S-Video
Input 9	In 9	AV, Tuner
Input 10	In 10	AUX, RGB

INSTALLER

KEY CODES

VCR

KEY FUNCTION	UNO-S1	VCR	KEY FUNCTION	UNO-S1	VCR
1	1	Digit 1	Pause	Pause	Pause
2	2	Digit 2	Record	Recrd	Record
3	3	Digit 3	Menu	Menu	Menu (PVR,Tivo)
4	4	Digit 4	Menu Up	MenuU	Menu Up
5	5	Digit 5	Menu Dn	MenuD	Menu Down
6	6	Digit 6	Menu Left	MenuL	Menu Left
7	7	Digit 7	Menu Right	MenuR	Menu Right
8	8	Digit 8	Select	Sel	Menu Select
9	9	Digit 9	Exit	Exit	Exit, Cancel
0	0	Digit 0	Display	Displ	Display, OSD, Info
Volume Up	VolUp	Volume Up	Guide	Guide	Guide,VCR+,Prgrm
Volume Down	VolDn	Volume Down	Page Up	PageU	Thmubs Up
Mute	Mutte	Mute	Page Down	PageD	Thmubs Down
Channel Up	Ch Up	Channel Up	Disk	Disk	Learned Only
Channel Dn	Ch Dn	Channel Down	Plus 10	Pls10	+100
Power	Power	Power On/Off	Open/Close	Op/Cl	Learned Only
Enter	Enter	Channel Enter	Random	Randm	Learned Only
Prev Channel	PrvCh	Last Channel	Track Fwd	TkFwd	QuickSkip/Adv,Indx TrkUp
TV/Video	TVVid	Learned Only	Track Rev	TkRev	Instnt Rplay,Indx Trk Dn
TV/VCR	TVVCR	Learned Only	Sur On/Off	SurOn	Learned Only
A/B	A / B	Learned Only	Sur Mode	SurMd	Learned Only
TV/DVD	TVDVD	Learned Only	Surround Up	SurUp	Learned Only
TV/LD	TV LD	Learned Only	Surround Dn	SurDn	Learned Only
Input	Input	TV/VCR	PIP	PIP	Learned Only
TV/DSS	TVDSS	Learned Only	PIP Move	PIP M	Learned Only
Play	Play	Play	PIP Swap	PIP S	Learned Only
Stop	Stop	Stop	Program	Progm	Learned Only
Search Fwd	SrchF	Fast Forward	Sleep	Sleep	Learned Only
Search Rev	SrchR	Rewind	On	On	On, Power On/Off

INSTALLER KEY CODES VCR

KEY FUNCTION	UNO-S1	VCR	KEY FUNCTION	UNO-S1	VCR
Off	Off	Off, Power On/Off	PIP Chan Up	PIPCU	Learned Only
11	11	Learned Only	PIP Chan Dn	PIP CD	Learned Only
12	12	Learned Only	Input 1	In 1	VID1,Video,TVp1
13	13	Learned Only	Input 2	In 2	VID2,TVp2
14	14	Learned Only	Input 3	In 3	VID3,TVp3
15	15	Learned Only	Input 4	In 4	VID4,TVp4
16	16	Learned Only	Input 5	In 5	VID5,AV1,VCR,BNC
Bright	Brght	Learned Only	Input 6	In 6	VID6,AV2,VDP,DVD,DVI
Dim	Dim	Learned Only	Input 7	In 7	TV, Component
Close	Close	Learned Only	Input 8	In 8	CAB,SAT,S-Video
Open	Open	Learned Only	Input 9	In 9	AV, Tuner
Halt	Halt	Learned Only	Input 10	In 10	AUX, RGB
AM/FM	AM/FM	Learned Only			
Cue	Cue	Learned Only			
Disk Up	DiskU	Learned Only			
Disk Down	DiskD	Learned Only			
Info	Info	Learned Only			
External Src	ExtSr	Input Select			
Live/Intro	Intro	Return to Live,Auto Track			
Menu	Menu	Menu			
Back	Back	Clear			
Fav Channel	FavCh	Replay Zones, Indx Mark			
Display Fmt	DFrmt	Record Speed			
SAP	SAP	SAP, CC			
Slow	Slow	Slow			
PIP On	PIPOn	Learned Only			
PIP Off	PIPOf	Learned Only			
PIP Freeze	PIPFr	Learned Only			
PIP Input	PIPIn	Learned Only			

INSTALLER

KEY CODES

LASER DISC

KEY FUNCTION	UNO-S1	LASER DISC	KEY FUNCTION	UNO-S1	LASER DISC
1	1	Digit 1	Pause	Pause	Pause
2	2	Digit 2	Record	Recrd	Learned Only
3	3	Digit 3	Menu	Menu	Menu, Program
4	4	Digit 4	Menu Up	MenuU	Menu Up
5	5	5Digit 5	Menu Dn	MenuD	Menu Down
6	6	6Digit 6	Menu Left	MenuL	Menu Left
7	7	Digit 7	Menu Right	MenuR	Menu Right
8	8	Digit 8	Select	Sel	Menu Select
9	9	Digit 9	Exit	Exit	Exit, Cancel
0	0	Digit 0	Display	Displ	Display, OSD, Info
Volume Up	VolUp	Volume Up	Guide	Guide	Learned Only
Volume Down	VolDn	Volume Down	Page Up	PageU	Disk Skip, Disk Up
Mute	Mute	Mute	Page Down	PageD	Disk Down
Channel Up	Ch Up	Learned Only	Disk	Disk	Learned Only
Channel Dn	Ch Dn	Learned Only	Plus 10	Pls10	+10
Power	Power	Power On/Off	Open/Close	Op/Cl	Learned Only
Enter	Enter	Learned Only	Random	Randm	Learned Only
Prev Channel	PrvCh	Repeat	Track Fwd	TkFwd	Chapter/Skip Up
TV/Video	TVVid	Learned Only	Track Rev	TkRev	Chapter/Skip Down
TV/VCR	TVVCR	Learned Only	Sur On/Off	SurOn	Audio
A/B	A / B	Learned Only	Sur Mode	SurMd	Learned Only
TV/DVD	TVDVD	Learned Only	Surround Up	SurUp	Learned Only
TV/LD	TV LD	Learned Only	Surround Dn	SurDn	Learned Only
Input	Input	TV,LD,Input Select	PIP	PIP	Learned Only
TV/DSS	TVDSS	Learned Only	PIP Move	PIP M	Learned Only
Play	Play	Play	PIP Swap	PIP S	Learned Only
Stop	Stop	Stop	Program	Progm	Learned Only
Search Fwd	SrchF	Chapter/Skip Up	Sleep	Sleep	Learned Only
Search Rev	SrchR	Chapter/Skip Dn	On	On	On, Power On/Off

INSTALLER KEY CODES LASER DISC

KEY FUNCTION	UNO-S1	LASER DISC	KEY FUNCTION	UNO-S1	LASER DISC
Off	Off	Off, Power On/Off	PIP Chan Up	PIP CU	Learned Only
11	11	Learned Only	PIP Chan Dn	PIP CD	Learned Only
12	12	Learned Only	Input 1	In 1	VID1, Video, TVp1
13	13	Learned Only	Input 2	In 2	VID2, TVp2
14	14	Learned Only	Input 3	In 3	VID3, TVp3
15	15	Learned Only	Input 4	In 4	VID4, TVp4
16	16	Learned Only	Input 5	In 5	VID5, AV1, VCR, BNC
Bright	Brght	Learned Only	Input 6	In 6	VID6, AV2, VDR, DVD, DVI
Dim	Dim	Learned Only	Input 7	In 7	TV, Component
Close	Close	Learned Only	Input 8	In 8	CAB, SAT, S-Video
Open	Open	Learned Only	Input 9	In 9	AV, Tuner
Halt	Halt	Learned Only	Input 10	In 10	AUX, RGB
AM/FM	AM/FM	Learned Only			
Cue	Cue	Learned Only			
Disk Up	DiskU	Learned Only			
Disk Down	DiskD	Learned Only			
Info	Info	Learned Only			
External Src	ExtSr	Ext AV Src, CDV, VCD, Karaoke			
Live/Intro	Intro	Intro, Search, Scan			
Menu	Menu	Learned Only			
Back	Back	Learned Only			
Fav Channel	FavCh	Mark			
Display Fmt	DFrmt	Learned Only			
SAP	SAP	Subtitle, CC			
Slow	Slow	Slow			
PIP On	PIPOn	Learned Only			
PIP Off	PIPOf	Learned Only			
PIP Freeze	PIPFr	Learned Only			
PIP Input	PIPIn	Learned Only			

INSTALLER

KEY CODES

DVD

KEY FUNCTION	UNO-S1	DVD	KEY FUNCTION	UNO-S1	DVD
1	1	Digit 1, Track 1	Pause	Pause	Pause
2	2	Digit 2, Track 2	Record	Recrd	Record
3	3	Digit 3, Track 3	Menu	Menu	Disk Menu
4	4	Digit 4, Track 4	Menu Up	MenuU	Menu Up
5	5	Digit 5, Track 5	Menu Dn	MenuD	Menu Dn
6	6	Digit 6, Track 6	Menu Left	MenuL	Menu Left
7	7	Digit 7, Track 7	Menu Right	MenuR	Menu right
8	8	Digit 8,Track 8	Select	Sel	Menu Select
9	9	Digit 9, Track 9	Exit	Exit	Exit, Cancel, Return
0	0	Digit 0, Track 10	Display	Displ	Display, OSD, Info
Volume Up	VolUp	Volume Up	Guide	Guide	Title
Volume Down	VolDn	Volume Down	Page Up	PageU	Disk Skip, Disk Up
Mute	Mute	Mute	Page Down	PageD	Disk Down
Channel Up	Ch Up	Channel Up	Disk	Disk	Learned Only
Channel Dn	Ch Dn	Channel Down	Plus 10	Pls10	+100. +10
Power	Power	Power On/Off	Open/Close	Op/Cl	Learned Only
Enter	Enter	Channel Enter	Random	Randm	Learned Only
Prev Channel	PrvCh	Last Channel,Repeat	Track Fwd	TkFwd	Chapter/Skip Up
TV/Video	TVVid	Learned Only	Track Rev	TkRev	Chapter/Skip Down
TV/VCR	TVVCR	Learned Only	Sur On/Off	SurOn	Audio, Language
A/B	A / B	Learned Only	Sur Mode	SurMd	Learned Only
TV/DVD	TVDVD	Learned Only	Surround Up	SurUp	Learned Only
TV/LD	TV LD	Learned Only	Surround Dn	SurDn	Learned Only
Input	Input	TV/DVD,Input Select	PIP	PIP	Learned Only
TV/DSS	TVDSS	Learned Only	PIP Move	PIP M	Learned Only
Play	Play	Play	PIP Swap	PIP S	Learned Only
Stop	Stop	Stop	Program	Progm	Learned Only
Search Fwd	SrchF	Fast Forward	Sleep	Sleep	Learned Only
Search Rev	SrchR	Rewind	On	On	On, Power On/Off

INSTALLER KEY CODES DVD

KEY FUNCTION	UNO-S1	DVD	KEY FUNCTION	UNO-S1	DVD
Off	Off	Off, Power On/Off	PIP Chan Up	PIP CU	Learned Only
11	11	Learned Only	PIP Chan Dn	PIP CD	Learned Only
12	12	Learned Only	Input 1	In 1	VID1,Video,TVp1
13	13	Learned Only	Input 2	In 2	VID2,TVp2
14	14	Learned Only	Input 3	In 3	VID3,TVp3
15	15	Learned Only	Input 4	In 4	VID4,TVp4
16	16	Learned Only	Input 5	In 5	VID5,AV1,VCR,BNC
Bright	Brght	Learned Only	Input 6	In 6	VID6,AV2,VDP,DVD,DVI
Dim	Dim	Learned Only	Input 7	In 7	TV, Component
Close	Close	Learned Only	Input 8	In 8	CAB,SAT,S-Video
Open	Open	Learned Only	Input 9	In 9	AV, Tuner
Halt	Halt	Learned Only	Input 10	In 10	AUX, RGB
AM/FM	AM/FM	Learned Only			
Cue	Cue	Learned Only			
Disk Up	DiskU	Learned Only			
Disk Down	DiskD	Learned Only			
Info	Info	Learned Only			
External Src	ExtSr	External AV Source			
Live/Intro	Intro	Intro,Search,Scan			
Menu	Menu	Setup Menu			
Back	Back	Clear			
Fav Channel	FavCh	Mark			
Display Fmt	DFrmt	Format Wide,Zoom,Aspect			
SAP	SAP	Subtitle, CC			
Slow	Slow	Slow			
PIP On	PIPOn	Learned Only			
PIP Off	PIPOf	Learned Only			
PIP Freeze	PIPFr	Learned Only			
PIP Input	PIPIIn	Learned Only			

INSTALLER

KEY CODES

RECEIVER

KEY FUNCTION	UNO-S1	RECEIVER	KEY FUNCTION	UNO-S1	RECEIVER
1	1	Digit 1	Pause	Pause	Pause
2	2	Digit 2	Record	Recrd	Record
3	3	Digit 3	Menu	Menu	Disk menu, Menu
4	4	Digit 4	Menu Up	MenuU	Menu Up, Adjust Up
5	5	Digit 5	Menu Dn	MenuD	Menu Dn, Adjust Dn
6	6	Digit 6	Menu Left	MenuL	Menu Left
7	7	Digit 7	Menu Right	MenuR	Menu Right
8	8	Digit 8	Select	Sel	Menu Select, Continue
9	9	Digit 9	Exit	Exit	Exit, Cancel
0	0	Digit 0	Display	Displ	Display, OSD, Info
Volume Up	VolUp	Volume Up	Guide	Guide	Title
Volume Down	VolDn	Volume Down	Page Up	PageU	Adjust Up
Mute	Mute	Mute	Page Down	PageD	Adjust Down
Channel Up	Ch Up	Preset Up	Disk	Disk	Learned Only
Channel Dn	Ch Dn	Preset Down	Plus 10	Pls10	Band, FM/AM
Power	Power	Power On/Off	Open/Close	Op/Cl	Learned Only
Enter	Enter	5.1, Prologic	Random	Randm	Random
Prev Channel	PrvCh	Last Channel, Repeat	Track Fwd	TkFwd	Skip Up
TV/Video	TVVid	Learned Only	Track Rev	TkRev	Skip Down
TV/VCR	TVVCR	Learned Only	Sur On/Off	SurOn	Srrd Mode/On Off,Audio Lang
A/B	A / B	Learned Only	Sur Mode	SurMd	Learned Only
TV/DVD	TVDVD	Learned Only	Surround Up	SurUp	Learned Only
TV/LD	TV LD	Learned Only	Surround Dn	SurDn	Learned Only
Input	Input	DVD/Tuner,Input Select	PIP	PIP	Learned Only
TV/DSS	TVDSS	Learned Only	PIP Move	PIP M	Learned Only
Play	Play	Play	PIP Swap	PIP S	Learned Only
Stop	Stop	Stop	Program	Progm	Learned Only
Search Fwd	SrchF	Fast Forward	Sleep	Sleep	Learned Only
Search Rev	SrchR	Rewind	On	On	On, Power On/Off

INSTALLER KEY CODES RECEIVER

KEY FUNCTION	UNO-S1	RECEIVER
Off	Off	Off, Power On/Off
11	11	Learned Only
12	12	Learned Only
13	13	Learned Only
14	14	Learned Only
15	15	Learned Only
16	16	Learned Only
Bright	Brght	Learned Only
Dim	Dim	Learned Only
Close	Close	Learned Only
Open	Open	Learned Only
Halt	Halt	Learned Only
AM/FM	AM/FM	Learned Only
Cue	Cue	Learned Only
Disk Up	DiskU	Learned Only
Disk Down	DiskD	Learned Only
Info	Info	Learned Only
External Src	ExtSr	External AV Source
Live/Intro	Intro	Intro,Search,Scan
Menu	Menu	Menu
Back	Back	Clear
Fav Channel	FavCh	Mark
Display Fmt	DFrmt	FormatWide,Zoom,Aspect
SAP	SAP	Learned Only
Slow	Slow	Slow
PIP On	PIPOn	Learned Only
PIP Off	PIPOf	Learned Only
PIP Freeze	PIPFr	Learned Only
PIP Input	PIPIIn	Learned Only

KEY FUNCTION	UNO-S1	RECEIVER
PIP Chan Up	PIP CU	Learned Only
PIP Chan Dn	PIP CD	Learned Only
Input 1	In 1	CD
Input 2	In 2	Tuner
Input 3	In 3	DVD, LD
Input 4	In 4	VCR, VID1
Input 5	In 5	VID5,AV1,VCR,BNC
Input 6	In 6	TV, VID2
Input 7	In 7	LD, VID3
Input 8	In 8	AUX, VID4
Input 9	In 9	DAT, Cable
Input 10	In 10	Phono SAT

INSTALLER

KEY CODES

AMP/MISC AUDIO

KEY FUNCTION	UNO-S1	AMP/MISC AUDIO	KEY FUNCTION	UNO-S1	AMP/MISC AUDIO
1	1	Digit 1	Pause	Pause	Pause
2	2	Digit 2	Record	Recrd	Record
3	3	Digit 3	Menu	Menu	Menu, Program
4	4	Digit 4	Menu Up	MenuU	Menu Up, Adjust Up
5	5	Digit 5	Menu Dn	MenuD	Menu Dn, Adjust Dn
6	6	Digit 6	Menu Left	MenuL	Menu Left
7	7	Digit 7	Menu Right	MenuR	Menu Right
8	8	Digit 8	Select	Sel	Menu Select, Cont
9	9	Digit 9	Exit	Exit	Exit, Cancel
0	0	Digit 0	Display	Displ	Display, OSD, Info
Volume Up	VolUp	Volume Up	Guide	Guide	Learned Only
Volume Down	VolDn	Volume Down	Page Up	PageU	Adjust Up
Mute	Mute	Mute	Page Down	PageD	Adjust Down
Channel Up	Ch Up	Preset Up	Disk	Disk	Learned Only
Channel Dn	Ch Dn	Preset Down	Plus 10	Pls10	Band, FM/AM
Power	Power	Power On/Off	Open/Close	Op/Cl	Learned Only
Enter	Enter	5.1, Prologic	Random	Randm	Learned Only
Prev Channel	PrvCh	Repeat	Track Fwd	TkFwd	Skip Up
TV/Video	TVVid	Learned Only	Track Rev	TkRev	Skip Down
TV/VCR	TVVCR	Learned Only	Sur On/Off	SurOn	Srrd Mode/On Off,Audio Lang
A/B	A / B	Learned Only	Sur Mode	SurMd	Learned Only
TV/DVD	TVDVD	Learned Only	Surround Up	SurUp	Learned Only
TV/LD	TV LD	Learned Only	Surround Dn	SurDn	Learned Only
Input	Input	Bypass,Input Slct	PIP	PIP	Learned Only
TV/DSS	TVDSS	Learned Only	PIP Move	PIP M	Learned Only
Play	Play	Play	PIP Swap	PIP S	Learned Only
Stop	Stop	Stop	Program	Progm	Learned Only
Search Fwd	SrchF	Fast Forward	Sleep	Sleep	Learned Only
Search Rev	SrchR	Rewind	On	On	On, Power On/Off

INSTALLER KEY CODES AMP/MISC AUDIO

KEY FUNCTION	UNO-S1	AMP/MISC AUDIO	KEY FUNCTION	UNO-S1	AMP/MISC AUDIO
Off	Off	Off, Power On/Off	PIP Chan Up	PIP CU	Learned Only
11	11	Learned Only	PIP Chan Dn	PIP CD	Learned Only
12	12	Learned Only	Input 1	In 1	CD
13	13	Learned Only	Input 2	In 2	Tuner
14	14	Learned Only	Input 3	In 3	DVD, LD
15	15	Learned Only	Input 4	In 4	TAPE, MD
16	16	Learned Only	Input 5	In 5	VCR, VID1
Bright	Brght	Learned Only	Input 6	In 6	TV, VID2
Dim	Dim	Learned Only	Input 7	In 7	LD, VID3
Close	Close	Learned Only	Input 8	In 8	AUX, VID4
Open	Open	Learned Only	Input 9	In 9	DAT, Cable
Halt	Halt	Learned Only	Input 10	In 10	Phono, SAT
AM/FM	AM/FM	Learned Only			
Cue	Cue	Learned Only			
Disk Up	DiskU	Learned Only			
Disk Down	DiskD	Learned Only			
Info	Info	Learned Only			
External Src	ExtSr	External AV Source			
Live/Intro	Intro	Intro, Search, Scan			
Menu	Menu	Learned Only			
Back	Back	Clear			
Fav Channel	FavCh	Learned Only			
Display Fmt	DFrmt	Learned Only			
SAP	SAP	Learned Only			
Slow	Slow	Learned Only			
PIP On	PIPOn	Learned Only			
PIP Off	PIPOf	Learned Only			
PIP Freeze	PIPFr	Learned Only			
PIP Input	PIPIn	Learned Only			

INSTALLER

KEY CODES

CD

KEY FUNCTION	UNO-S1	CD	KEY FUNCTION	UNO-S1	CD
1	1	Digit 1, Track 1,Dsc1	Pause	Pause	Pause
2	2	Digit 2, Track 2,Dsc2	Record	Recrd	Record
3	3	Digit 3, Track 3,Dsc3	Menu	Menu	Disk, Edit
4	4	Digit 4, Track 4,Dsc4	Menu Up	MenuU	Menu Up
5	5	Digit 5, Track 5,Dsc5	Menu Dn	MenuD	Menu Down
6	6	Digit 6, Track 6,Dsc6	Menu Left	MenuL	Menu Left
7	7	Digit 7, Track 7,Dsc7	Menu Right	MenuR	Menu Right
8	8	Digit 8,Track 8,Dsc8	Select	Sel	Menu Select, Cont
9	9	Digit 9, Track 9,Dsc9	Exit	Exit	Exit, Cancel
0	0	Digit 0, Trck10,Dsc10	Display	Displ	Display, OSD, Info
Volume Up	VolUp	Volume Up	Guide	Guide	Group,Magazine
Volume Down	VolDn	Volume Down	Page Up	PageU	Disk Skip, Disk Up
Mute	Mute	Mute	Page Down	PageD	Disk Down
Channel Up	Ch Up	Learned Only	Disk	Disk	Learned Only
Channel Dn	Ch Dn	Learned Only	Plus 10	Pls10	+10, +100
Power	Power	Power On/Off	Open/Close	Op/Cl	Learned Only
Enter	Enter	Set	Random	Randm	Learned Only
Prev Channel	PrvCh	Repeat	Track Fwd	TkFwd	Skip Up
TV/Video	TVVid	Learned Only	Track Rev	TkRev	Skip Down
TV/VCR	TVVCR	Learned Only	Sur On/Off	SurOn	Learned Only
A/B	A / B	Learned Only	Sur Mode	SurMd	Learned Only
TV/DVD	TVDVD	Learned Only	Surround Up	SurUp	Learned Only
TV/LD	TV LD	Learned Only	Surround Dn	SurDn	Learned Only
Input	Input	DVD/Tuner Input Select	PIP	PIP	Learned Only
TV/DSS	TVDSS	Learned Only	PIP Move	PIP M	Learned Only
Play	Play	Play	PIP Swap	PIP S	Learned Only
Stop	Stop	Stop	Program	Progm	Learned Only
Search Fwd	SrchF	Fast Forward	Sleep	Sleep	Learned Only
Search Rev	SrchR	Rewind	On	On	On, Power On/Off

INSTALLER KEY CODES CD

KEY FUNCTION	UNO-S1	CD	KEY FUNCTION	UNO-S1	CD
Off	Off	Off, Power On/Off	PIP Chan Up	PIPCU	Learned Only
11	11	Learned Only	PIP Chan Dn	PIP CD	Learned Only
12	12	Learned Only	Input 1	In 1	CD
13	13	Learned Only	Input 2	In 2	Tuner
14	14	Learned Only	Input 3	In 3	DVD, LD
15	15	Learned Only	Input 4	In 4	Tape, MD
16	16	Learned Only	Input 5	In 5	VCR, VID1
Bright	Brght	Learned Only	Input 6	In 6	TV, VID2
Dim	Dim	Learned Only	Input 7	In 7	LD, VID3
Close	Close	Learned Only	Input 8	In 8	AUX, VID4
Open	Open	Learned Only	Input 9	In 9	DAT, Cable
Halt	Halt	Learned Only	Input 10	In 10	Phono, SAT
AM/FM	AM/FM	Learned Only			
Cue	Cue	Learned Only			
Disk Up	DiskU	Learned Only			
Disk Down	DiskD	Learned Only			
Info	Info	Learned Only			
External Src	ExtSr	CD/CDR/MD,Input Select			
Live/Intro	Intro	Intro,Search,Scan			
Menu	Menu	Menu, Program			
Back	Back	Track, Clear			
Fav Channel	FavCh	Finalize, Index			
Display Fmt	DFrmt	Learned Only			
SAP	SAP	Learned Only			
Slow	Slow	Learned Only			
PIP On	PIPOn	Learned Only			
PIP Off	PIPOf	Learned Only			
PIP Freeze	PIPFr	Learned Only			
PIP Input	PIPIIn	Learned Only			

INSTALLER

KEY CODES

HOME CONTROL

KEY FUNCTION	UNO-S1	HOME CONTROL	KEY FUNCTION	UNO-S1	HOME CONTROL
1	1	Digit 1	Pause	Pause	Pause
2	2	Digit 2	Record	Recrd	Record
3	3	Digit 3	Menu	Menu	Menu
4	4	Digit 4	Menu Up	MenuU	Menu Up, Mode
5	5	Digit 5	Menu Dn	MenuD	Menu Dn, Timer
6	6	Digit 6	Menu Left	MenuL	Menu Left,Oscillate
7	7	Digit 7	Menu Right	MenuR	Menu Right,Speed
8	8	Digit 8	Select	Sel	Menu Select, Light
9	9	Digit 9	Exit	Exit	Exit, Cancel
0	0	Digit 0	Display	Displ	Learned Only
Volume Up	VolUp	Volume Up	Guide	Guide	Learned Only
Volume Down	VolDn	Volume Down	Page Up	PageU	Learned Only
Mute	Mute	Mute	Page Down	PageD	Learned Only
Channel Up	Ch Up	Bright,Raise Up	Disk	Disk	Learned Only
Channel Dn	Ch Dn	Dim,Lower Down	Plus 10	Pls10	Learned Only
Power	Power	Power On/Off	Open/Close	Op/Cl	Learned Only
Enter	Enter	Learned Only	Random	Randm	Learned Only
Prev Channel	PrvCh	Learned Only	Track Fwd	TkFwd	Learned Only
TV/Video	TVVid	Learned Only	Track Rev	TkRev	Learned Only
TV/VCR	TVVCR	Learned Only	Sur On/Off	SurOn	Learned Only
A/B	A / B	Learned Only	Sur Mode	SurMd	Learned Only
TV/DVD	TVDVD	Learned Only	Surround Up	SurUp	Learned Only
TV/LD	TV LD	Learned Only	Surround Dn	SurMd	Learned Only
Input	Input	Home, Source	PIP	PIP	Learned Only
TV/DSS	TVDSS	Learned Only	PIP Move	PIP M	Learned Only
Play	Play	Play	PIP Swap	PIP S	Learned Only
Stop	Stop	Stop	Program	Progm	Learned Only
Search Fwd	SrchF	Fast Forward,Open	Sleep	Sleep	Learned Only
Search Rev	SrchR	Rewind, Close	On	On	On, Power On/Off

INSTALLER KEY CODES HOME CONTROL

KEY FUNCTION	UNO-S1	HOME CONTROL	KEY FUNCTION	UNO-S1	HOME CONTROL
Off	Off	Off, Power On/Off	PIP Chan Up	PIP CU	Learned Only
11	11	Learned Only	PIP Chan Dn	PIP CD	Learned Only
12	12	Learned Only	Input 1	In 1	Source/Scene 1
13	13	Learned Only	Input 2	In 2	Source/Scene 2
14	14	Learned Only	Input 3	In 3	Source/Scene 3
15	15	Learned Only	Input 4	In 4	Source/Scene 4
16	16	Learned Only	Input 5	In 5	Source/Scene 5
Bright	Brght	Learned Only	Input 6	In 6	Source/Scene 6
Dim	Dim	Learned Only	Input 7	In 7	Source/Scene 7
Close	Close	Learned Only	Input 8	In 8	Source/Scene 8
Open	Open	Learned Only	Input 9	In 9	Source/Scene 9
Halt	Halt	Learned Only	Input 10	In 10	Source/Scene 10
AM/FM	AM/FM	Learned Only			
Cue	Cue	Learned Only			
Disk Up	DiskU	Learned Only			
Disk Down	DiskD	Learned Only			
Info	Info	Learned Only			
External Src	ExtSr	External Source			
Live/Intro	Intro	Learned Only			
Menu	Menu	Learned Only			
Back	Back	Learned Only			
Fav Channel	FavCh	Learned Only			
Display Fmt	DFrmt	Learned Only			
SAP	SAP	Learned Only			
Slow	Slow	All On			
PIP On	PIPOn	Learned Only			
PIP Off	PIPOf	Learned Only			
PIP Freeze	PIPFr	Learned Only			
PIP Input	PIPIn	Learned Only			

TECHNICAL SPECIFICATION

CAV6.6 Controller/Amplifier

Dimensions:	17"W x 12"D x 3.5"H (43 x 30.5 x 9 cm)
Weight:	18 lbs. (8.1 kg)
Power Supply:	110 or 240 VAC
Fuse Rating:	110V input; F3A H 250V US and Canada 240V input; F1.25A H 250V Europe
Frequency Response:	20Hz-20kHz +/- 0.5dB
Watts per channel:	20 Watts RMS x 12 into 8 Ohms
Total Harmonic Distortion:	0.05%
Signal to Noise Ratio:	88dB
A/V Source Inputs:	7 (Including front AUX A/V input)
A/V Source Outputs:	6
Zones:	6
A-BUS Ready Ports:	4
Source Audio Input:	5V Peak to Peak, 10k Ohms
Source Audio Loop Output:	Unity Gain, 10k Ohms
Source Video Input:	1V Peak to Peak, 75 Ohms
Source Video Loop Output:	1V Peak to Peak, 75 Ohms
Zone Video Output:	1V Peak to Peak, 75 Ohms
Zone Variable Line Audio Output:	5.6V Peak to Peak, 4 Ohms @ 1KHz
Trigger Outputs:	6 Zone, 1 Common. 12VDC 50mA each
Trigger Inputs:	1 Home Theater

UNO-S2 Keypad

Dimensions:	3.65"W x 1.125"D x 4.3"H (9.2 x 10.9 x 2.8 cm) Fits 2 Gang UL/CSA Approved Junction Box
Weight:	6 oz. (170 g)
Power Requirements:	12 VDC 180mA
CAT-5 Connection:	110 punchdown

WARRANTY & REPAIR



The Russound CAV6.6 is fully guaranteed against all defects in materials and workmanship for two (2) years from the date of purchase. During this period, Russound will replace any defective parts and correct any defect in workmanship without charge for either parts or labor.

For this warranty to apply, the unit must be installed and used according to its written instructions. If service is necessary, it must be performed by Russound. The unit must be returned to Russound at the owner's expense and with prior written permission. Accidental damage and shipping damage are not considered defects, nor is damage resulting from abuse or from servicing by an agency or person not specifically authorized in writing by Russound.

This Warranty does not cover:

- Damage caused by abuse, accident, misuse, negligence, or improper installation or operation
- Power surges and lightning strikes
- Normal wear and maintenance
- Products that have been altered or modified
- Any product whose identifying number, decal, serial number, etc. has been altered, defaced or removed

Russound sells products only through authorized Dealers and Distributors to ensure that customers obtain proper support and service. Any Russound product purchased from an unauthorized dealer or other source, including retailers, mail order sellers and online sellers will not be honored or serviced under existing Russound warranty policy. Any sale of products by an unauthorized source or other manner not authorized by Russound shall void the warranty on the applicable product.

Damage to or destruction of components due to application of excessive power voids the warranty on those parts. In these cases, repairs will be made on the basis of the retail value of the parts and labor. To return for repairs, the unit must be shipped to Russound at the owner's expense, along with a note explaining the nature of service required. Be sure to pack the unit in a corrugated container with at least three (3) inches of resilient material to protect the unit from damage in transit.

Before returning a unit for repair, call Russound at (603) 659-5170 for a Return Authorization number. Write this number on the shipping label and ship to:

Russound
ATTN: Service
5 Forbes Road
Newmarket, NH 03857

Due to continual efforts to improve product quality as new technology and techniques become available, Russound/FMP, Inc. reserves the right to revise system specifications without notice.



CAV6.6

Six-Zone, Six-Source Audio-Video Controller Amplifier

INSTRUCTION MANUAL

Russound
5 Forbes Road, Newmarket, NH 03857
tel 603.659.5170 • fax 603.659.5388
e-mail: tech@russound.com
www.russound.com

Copyright ©2006 Russound® All rights reserved.
All trademarks are property of their respective owners.
A-BUS is a registered trademark of LeisureTech Electronics Pty Ltd Australia.
Specifications subject to change without notice.
Russound is not responsible for typographical errors or omissions.
For use with CAV6.6 Rev. 5 Hardware
28-1143 Rev. 5 05/10/06